

MC9S12DT256

Port Integration Module (PIM)

Block Guide

V03.04

Original Release Date: 19 NOV 2001
Revised: 24 JUL 2003

Motorola, Inc.

Motorola reserves the right to make changes without further notice to any products herein. Motorola makes no warranty, representation or guarantee regarding the suitability of its products for any particular purpose, nor does Motorola assume any liability arising out of the application or use of any product or circuit, and specifically disclaims any and all liability, including without limitation consequential or incidental damages. "Typical" parameters which may be provided in Motorola data sheets and/or specifications can and do vary in different applications and actual performance may vary over time. All operating parameters, including "Typicals" must be validated for each customer application by customer's technical experts. Motorola does not convey any license under its patent rights nor the rights of others. Motorola products are not designed, intended, or authorized for use as components in systems intended for surgical implant into the body, or other applications intended to support or sustain life, or for any other application in which the failure of the Motorola product could create a situation where personal injury or death may occur. Should Buyer purchase or use Motorola products for any such unintended or unauthorized application, Buyer shall indemnify and hold Motorola and its officers, employees, subsidiaries, affiliates, and distributors harmless against all claims, costs, damages, and expenses, and reasonable attorney fees arising out of, directly or indirectly, any claim of personal injury or death associated with such unintended or unauthorized use, even if such claim alleges that Motorola was negligent regarding the design or manufacture of the part. Motorola and  are registered trademarks of Motorola, Inc. Motorola, Inc. is an Equal Opportunity/Affirmative Action Employer.

©Motorola, Inc., 2001

Revision History

Version Number	Revision Date	Effective Date	Author	Description of Changes
V02.00	19 FEB 2001			Initial version for 2nd Barracuda revision started from Integration Guide PIM_9DP256 V01.00. Summary of changes: - Added Port A, B, E, K, and BKGD pin. - Added MODRR register. - Moved priority information into Table 2-1 and removed Table 4-1 - Removed reference to IPBus from Block Diagram
V02.01	28 MAR 2001	28 MAR 2001		- Updated due to requirements in SRS supplement
V02.02	17 JUL 2001	17 JUL 2001		- 1st official version by Technical Publishing
V02.03	03 AUG 2001	03 AUG 2001		- Capitalized all pin names to match Barracuda DUG. - Added full register names in memory map table. - Corrected typo in PPSJ description.
V02.04	11 OCT 2001	11 OCT 2001		- Updated references w.r.t. new family name HCS12.
V02.05	31 OCT 2001	31 OCT 2001		- Minor cleanup.
V02.06	12 NOV 2001	12 NOV 2001		- Removed subsection on unbonded port pins on 80 pin package. Shall be stated in DUG.
V03.00	19 NOV 2001	11 FEB 2001		- Added CAN0 to PJ[7:6] routing feature. - Removed table notes from table 3-4 to 3-6. - Added port ABEK note in Overview. - Updated block diagram. - Removed ports ABEK from table 2-1. - Changed to SRSv3 document format. - General cosmetic changes. - Replaced key wakeup limits by variables defined in DUG.
V03.01	04 MAR 2002	04 MAR 2002		- Document format updates.
V03.02	23 APR 2002	23 APR 2002		- Corrected PTH I/O register bit swap of bit 7 & 6 (SS2, SCK2).
V03.03	04 NOV 2002	04 NOV 2002		- Made document generic for 9DP256 and 9DT256 derivatives by introducing conditional text.
V03.04	24 JUL 2003	24 JUL 2003		- Corrected column header in table Pulse Detection Criteria

Table of Contents

Section 1 Introduction

1.1	Overview	11
1.2	Features	11
1.3	Block Diagram	12

Section 2 External Signal Description

2.1	Overview	13
2.2	Signal properties	13

Section 3 Memory Map/Register Definition

3.1	Register Descriptions	18
3.1.1	Port T Registers	19
3.1.2	Port S Registers	22
3.1.3	Port M Registers	26
3.1.4	Port P Registers	31
3.1.5	Port H Registers	35
3.1.6	Port J Registers	39

Section 4 Functional Description

4.1	General	43
4.1.1	I/O register	43
4.1.2	Input register	43
4.1.3	Data direction register	43
4.1.4	Reduced drive register	44
4.1.5	Pull device enable register	44
4.1.6	Polarity select register	44
4.2	Port T	44
4.3	Port S	45
4.4	Port M	45
4.4.1	Module Routing Register	45
4.5	Port P	45
4.6	Port H	47
4.7	Port J	47

4.8	Port A, B, E, K, and BKGD pin	48
4.9	External Pin Descriptions	48
4.10	Low Power Options	48
4.10.1	Run Mode.	48
4.10.2	Wait Mode	48
4.10.3	Stop Mode	48

Section 5 Initialization/Application Information

List of Figures

Figure 1-1	PIM_9DT256 Block Diagram	12
Figure 3-1	Port T I/O Register (PTT)	19
Figure 3-2	Port T Input Register (PTIT)	20
Figure 3-3	Port T Data Direction Register (DDRT)	20
Figure 3-4	Port T Reduced Drive Register (RDRT)	21
Figure 3-5	Port T Pull Device Enable Register (PERT)	21
Figure 3-6	Port T Polarity Select Register (PPST)	22
Figure 3-7	Port S I/O Register (PTS)	22
Figure 3-8	Port S Input Register (PTIS)	23
Figure 3-9	Port S Data Direction Register (DDRS)	23
Figure 3-10	Port S Reduced Drive Register (RDRS)	24
Figure 3-11	Port S Pull Device Enable Register (PERS)	24
Figure 3-12	Port S Polarity Select Register (PPSS)	25
Figure 3-13	Port S Wired-Or Mode Register (WOMS)	25
Figure 3-14	Port M I/O Register (PTM)	26
Figure 3-15	Port M Input Register (PTIM)	27
Figure 3-16	Port M Data Direction Register (DDRM)	27
Figure 3-17	Port M Reduced Drive Register (RDRM)	28
Figure 3-18	Port M Pull Device Enable Register (PERM)	28
Figure 3-19	Port M Polarity Select Register (PPSM)	29
Figure 3-20	Port M Wired-Or Mode Register (WOMM)	29
Figure 3-21	Module Routing Register (MODRR)	30
Figure 3-22	Port P I/O Register (PTP)	31
Figure 3-23	Port P Input Register (PTIP)	31
Figure 3-24	Port P Data Direction Register (DDRP)	32
Figure 3-25	Port P Reduced Drive Register (RDRP)	32
Figure 3-26	Port P Pull Device Enable Register (PERP)	33
Figure 3-27	Port P Polarity Select Register (PPSP)	33
Figure 3-28	Port P Interrupt Enable Register (PIEP)	34
Figure 3-29	Port P Interrupt Flag Register (PIFP)	34
Figure 3-30	Port H I/O Register (PTH)	35
Figure 3-31	Port H Input Register (PTIH)	35
Figure 3-32	Port H Data Direction Register (DDRH)	36

Figure 3-33 Port H Reduced Drive Register (RDRH) 36

Figure 3-34 Port H Pull Device Enable Register (PERH) 37

Figure 3-35 Port H Polarity Select Register (PPSH) 37

Figure 3-36 Port H Interrupt Enable Register (PIEH) 38

Figure 3-37 Port H Interrupt Flag Register (PIFH) 38

Figure 3-38 Port J I/O Register (PTJ) 39

Figure 3-39 Port J Input Register (PTIJ) 39

Figure 3-40 Port J Data Direction Register (DDRJ) 40

Figure 3-41 Port J Reduced Drive Register (RDRJ) 40

Figure 3-42 Port J Pull Device Enable Register (PERJ) 41

Figure 3-43 Port J Polarity Select Register (PPSJ) 41

Figure 3-44 Port J Interrupt Enable Register (PIEJ) 42

Figure 3-45 Port J Interrupt Flag Register (PIFJ) 42

Figure 4-1 Illustration of I/O pin functionality 44

Figure 4-2 Interrupt Glitch Filter on Port P, H and J (PPS=0) 46

Figure 4-3 Pulse Illustration 47

List of Tables

Table 2-1	Pin Functions and Priorities	13
Table 3-1	PIM_9DT256 Memory Map	17
Table 3-2	Pin Configuration Summary	19
Table 3-3	CAN0 Routing	30
Table 3-4	CAN4 Routing	30
Table 3-5	SPI0 Routing	30
Table 3-6	SPI1 Routing	30
Table 3-7	SPI2 Routing	31
Table 4-1	Implemented modules on derivatives	45
Table 4-2	Pulse Detection Criteria	46

Preface

Terminology

Acronyms and Abbreviations	

Section 1 Introduction

1.1 Overview

The Port Integration Module establishes the interface between the peripheral modules and the I/O pins for all ports except AD0 and AD1.

NOTE: *Port A, B, E, and K are related to the core logic and multiplexed bus interface. Refer to the HCS12 Core User Guide for details.*

This section covers:

- Port T connected to the timer module
- The serial port S associated with 2 SCI and 1 SPI modules
- Port M associated with 2 CAN modules
- Port P connected to the PWM and 2 SPI modules, which also can be used as an external interrupt source
- The standard I/O ports H and J associated with the first and third CAN module and the IIC interface. These ports can also be used as external interrupt sources.

Each I/O pin can be configured by several registers in order to select data direction and drive strength, to enable and select pull-up or pull-down resistors. On certain pins also interrupts can be enabled which result in status flags.

The I/O's of 2 CAN and all 3 SPI modules can be routed from their default location to determined pins.

The implementation of the Port Integration Module is device dependent.

1.2 Features

A standard port pin has the following minimum features:

- Input/output selection
- 5V output drive with two selectable drive strengths
- 5V digital and analog input
- Input with selectable pull-up or pull-down device

Optional features:

- Open drain for wired-or connections
- Interrupt inputs with glitch filtering

1.3 Block Diagram

The following figure is a block diagram of the PIM_9DT256.

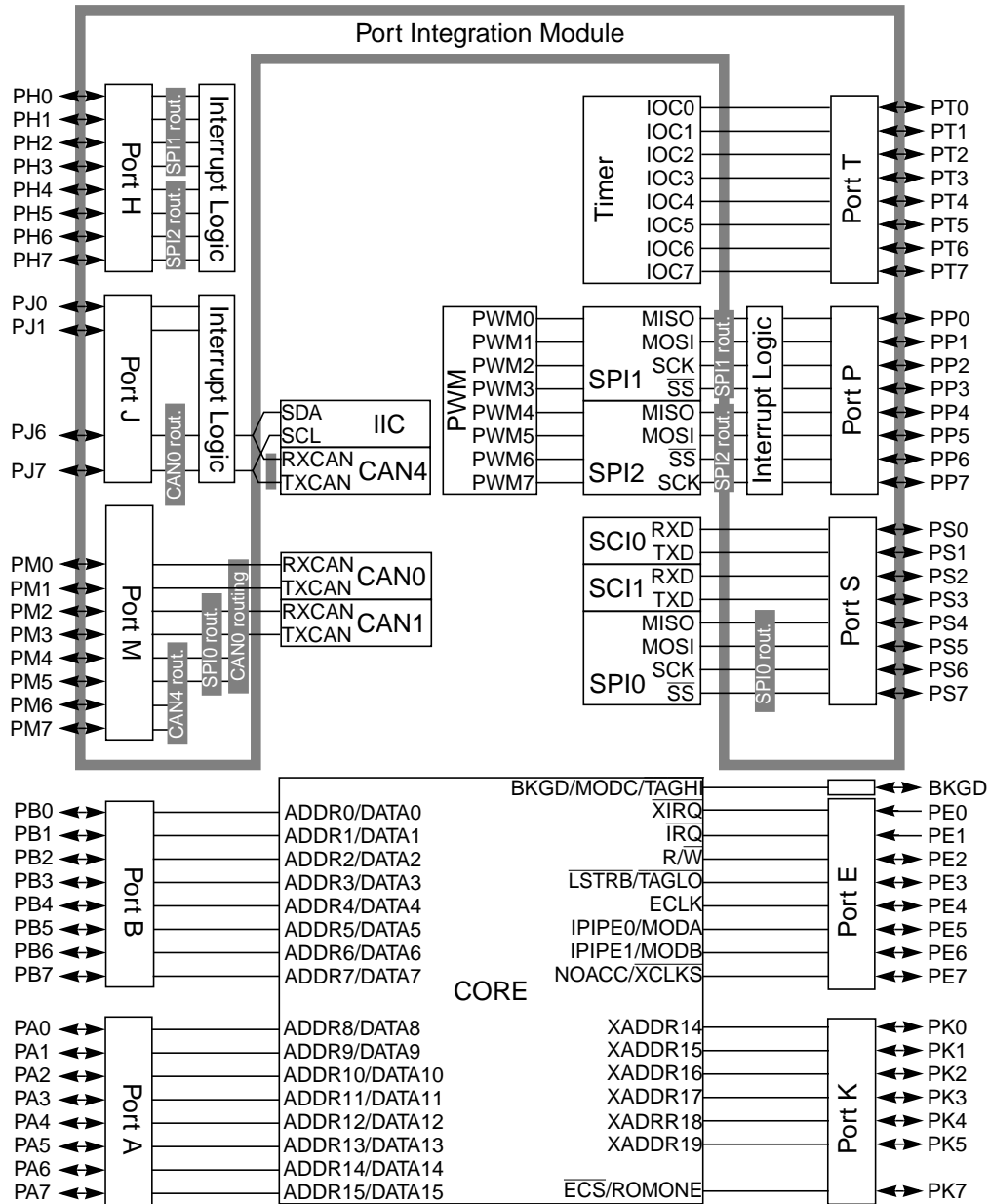

Figure 1-1 PIM_9DT256 Block Diagram

Section 2 External Signal Description

2.1 Overview

This section lists and describes the signals that do connect off-chip.

2.2 Signal properties

Table 2-1 shows all the pins and their functions that are controlled by the PIM_9DT256. If there is more than one function associated with a pin, the priority is indicated by the position in the table from top (highest priority) to down (lowest priority).

Table 2-1 Pin Functions and Priorities

Port	Pin Name	Pin Function & Priority	Description	Pin Function after Reset
Port T	PT[7:0]	IOC[7:0]	Enhanced Capture Timer Channels 7 to 0	GPIO
		GPIO	General-purpose I/O	
Port S	PS7	$\overline{SS}0$	Serial Peripheral Interface 0 slave select output in master mode, input in slave mode or master mode.	GPIO
		GPIO	General-purpose I/O	
	PS6	SCK0	Serial Peripheral Interface 0 serial clock pin	
		GPIO	General-purpose I/O	
	PS5	MOSI0	Serial Peripheral Interface 0 master out/slave in pin	
		GPIO	General-purpose I/O	
	PS4	MISO0	Serial Peripheral Interface 0 master in/slave out pin	
		GPIO	General-purpose I/O	
	PS3	TXD1	Serial Communication Interface 1 transmit pin	
		GPIO	General-purpose I/O	
	PS2	RXD1	Serial Communication Interface 1 receive pin	
		GPIO	General-purpose I/O	
	PS1	TXD0	Serial Communication Interface 0 transmit pin	
		GPIO	General-purpose I/O	
	PS0	RXD0	Serial Communication Interface 0 receive pin	
		GPIO	General-purpose I/O	

Port	Pin Name	Pin Function & Priority	Description	Pin Function after Reset	
Port M	PM7	TXCAN4	MSCAN4 transmit pin	GPIO	
		GPIO	General-purpose I/O		
	PM6	RXCAN4	MSCAN4 receive pin		
		GPIO	General-purpose I/O		
	PM5	TXCAN0	MSCAN0 transmit pin		
		TXCAN4	MSCAN4 transmit pin		
		SCK0	Serial Peripheral Interface 0 serial clock pin		
		GPIO	General-purpose I/O		
	PM4	RXCAN0	MSCAN0 receive pin		
		RXCAN4	MSCAN4 receive pin		
		MOSI0	Serial Peripheral Interface 0 master out/slave in pin		
		GPIO	General-purpose I/O		
	PM3	TXCAN1	MSCAN1 transmit pin		
		TXCAN0	MSCAN0 transmit pin		
		$\overline{SS}0^1$	Serial Peripheral Interface 0 slave select output in master mode, input for slave mode or master mode.		
		GPIO	General-purpose I/O		
	PM2	RXCAN1	MSCAN1 receive pin		
		RXCAN0	MSCAN0 receive pin		
		MISO0 ¹	Serial Peripheral Interface 0 master in/slave out pin		
		GPIO	General-purpose I/O		
PM1	TXCAN0	MSCAN0 transmit pin			
	GPIO	General-purpose I/O			
PM0	RXCAN0	MSCAN0 receive pin			
	GPIO	General-purpose I/O			

Port	Pin Name	Pin Function & Priority	Description	Pin Function after Reset
Port P	PP7	PWM7	Pulse Width Modulator channel 7	GPIO
		SCK2	Serial Peripheral Interface 2 serial clock pin	
		GPIO/KWP7	General-purpose I/O with interrupt	
	PP6	PWM6	Pulse Width Modulator channel 6	
		$\overline{SS}2$	Serial Peripheral Interface 2 slave select output in master mode, input for slave mode or master mode.	
		GPIO/KWP6	General-purpose I/O with interrupt	
	PP5	PWM5	Pulse Width Modulator channel 5	
		MOSI2	Serial Peripheral Interface 2 master out/slave in pin	
		GPIO/KWP5	General-purpose I/O with interrupt	
	PP4	PWM4	Pulse Width Modulator channel 4	
		MISO2	Serial Peripheral Interface 2 master in/slave out pin	
		GPIO/KWP4	General-purpose I/O with interrupt	
	PP3	PWM3	Pulse Width Modulator channel 3	
		$\overline{SS}1$	Serial Peripheral Interface 1 slave select output in master mode, input for slave mode or master mode.	
		GPIO/KWP3	General-purpose I/O with interrupt	
	PP2	PWM2	Pulse Width Modulator channel 2	
		SCK1	Serial Peripheral Interface 1 serial clock pin	
		GPIO/KWP2	General-purpose I/O with interrupt	
	PP1	PWM1	Pulse Width Modulator channel 1	
		MOSI1	Serial Peripheral Interface 1 master out/slave in pin	
		GPIO/KWP1	General-purpose I/O with interrupt	
PP0	PWM0	Pulse Width Modulator channel 0		
	MISO1	Serial Peripheral Interface 1 master in/slave out pin		
	GPIO/KWP0	General-purpose I/O with interrupt		

Port	Pin Name	Pin Function & Priority	Description	Pin Function after Reset
Port H	PH7	SS2	Serial Peripheral Interface 2 slave select output in master mode, input for slave mode or master mode.	GPIO
		GPIO/KWH7	General-purpose I/O with interrupt	
	PH6	SCK2	Serial Peripheral Interface 2 serial clock pin	
		GPIO/KWH6	General-purpose I/O with interrupt	
	PH5	MOSI2	Serial Peripheral Interface 2 master out/slave in pin	
		GPIO/KWH5	General-purpose I/O with interrupt	
	PH4	MISO2	Serial Peripheral Interface 2 master in/slave out pin	
		GPIO/KWH4	General-purpose I/O with interrupt	
	PH3	SS1	Serial Peripheral Interface 1 slave select output in master mode, input for slave mode or master mode.	
		GPIO/KWH3	General-purpose I/O with interrupt	
	PH2	SCK1	Serial Peripheral Interface 1 serial clock pin	
		GPIO/KWH2	General-purpose I/O with interrupt	
	PH1	MOSI1	Serial Peripheral Interface 1 master out/slave in pin	
		GPIO/KWH1	General-purpose I/O with interrupt	
PH0	MISO1	Serial Peripheral Interface 1 master in/slave out pin		
	GPIO/KWH0	General-purpose I/O with interrupt		
Port J	PJ7	TXCAN4	MSCAN4 transmit pin	GPIO
		SCL	Inter Integrated Circuit serial clock line	
		TXCAN0	MSCAN0 transmit pin	
		GPIO/KWJ7	General-purpose I/O with interrupt	
	PJ6	RXCAN4	MSCAN4 receive pin	
		SDA	Inter Integrated Circuit serial data line	
		RXCAN0	MSCAN0 receive pin	
		GPIO/KWJ6	General-purpose I/O with interrupt	
	PJ[1:0]	GPIO/KWJ[1:0]	General-purpose I/O with interrupt	

NOTES:

1. If CAN0 is routed to PM[3:2] the SPI0 can still be used in bidirectional master mode. Refer to SPI Block Guide for details.

Section 3 Memory Map/Register Definition

This section provides a detailed description of all registers.

The following table shows the register map of the Port Integration Module.

Table 3-1 PIM_9DT256 Memory Map

Address offset	Use	Access
\$00	Port T I/O Register (PTT)	RW
\$01	Port T Input Register (PTIT)	R
\$02	Port T Data Direction Register (DDRT)	RW
\$03	Port T Reduced Drive Register (RDRT)	RW
\$04	Port T Pull Device Enable Register (PERT)	RW
\$05	Port T Polarity Select Register (PPST)	RW
\$06	Reserved	-
\$07	Reserved	-
\$08	Port S I/O Register (PTS)	RW
\$09	Port S Input Register (PTIS)	R
\$0A	Port S Data Direction Register (DDRS)	RW
\$0B	Port S Reduced Drive Register (RDRS)	RW
\$0C	Port S Pull Device Enable Register (PERS)	RW
\$0D	Port S Polarity Select Register (PPSS)	RW
\$0E	Port S Wired-Or Mode Register (WOMS)	RW
\$0F	Reserved	-
\$10	Port M I/O Register (PTM)	RW
\$11	Port M Input Register (PTIM)	R
\$12	Port M Data Direction Register (DDRM)	RW
\$13	Port M Reduced Drive Register (RDRM)	RW
\$14	Port M Pull Device Enable Register (PERM)	RW
\$15	Port M Polarity Select Register (PPSM)	RW
\$16	Port M Wired-Or Mode Register (WOMM)	RW
\$17	Module Routing Register (MODRR)	RW
\$18	Port P I/O Register (PTP)	RW
\$19	Port P Input Register (PTIP)	R
\$1A	Port P Data Direction Register (DDRP)	RW
\$1B	Port P Reduced Drive Register (RDRP)	RW
\$1C	Port P Pull Device Enable Register (PERP)	RW
\$1D	Port P Polarity Select Register (PPSP)	RW
\$1E	Port P Interrupt Enable Register (PIEP)	RW
\$1F	Port P Interrupt Flag Register (PIFP)	RW
\$20	Port H I/O Register (PTH)	RW
\$21	Port H Input Register (PTIH)	R
\$22	Port H Data Direction Register (DDRH)	RW
\$23	Port H Reduced Drive Register (RDRH)	RW
\$24	Port H Pull Device Enable Register (PERH)	RW
\$25	Port H Polarity Select Register (PPSH)	RW

\$26	Port H Interrupt Enable Register (PIEH)	RW
\$27	Port H Interrupt Flag Register (PIFH)	RW
\$28	Port J I/O Register (PTJ)	RW ¹
\$29	Port J Input Register (PTIJ)	R
\$2A	Port J Data Direction Register (DDRJ)	RW ¹
\$2B	Port J Reduced Drive Register (RDRJ)	RW ¹
\$2C	Port J Pull Device Enable Register (PERJ)	RW ¹
\$2D	Port J Polarity Select Register (PPSJ)	RW ¹
\$2E	Port J Interrupt Enable Register (PIEJ)	RW ¹
\$2F	Port J Interrupt Flag Register (PIFJ)	RW ¹
\$30 - \$3F	Reserved	-

NOTES:

1. Write access not applicable for one or more register bits. Please refer to detailed signal description.

NOTE: *Register Address = Base Address + Address Offset, where the Base Address is defined at the MCU level and the Address Offset is defined at the module level.*

3.1 Register Descriptions

The following table summarizes the effect on the various configuration bits, data direction (DDR), output level (I/O), reduced drive (RDR), pull enable (PE), pull select (PS) and interrupt enable (IE) for the ports. The configuration bit PS is used for two purposes:

1. Configure the sensitive interrupt edge (rising or falling), if interrupt is enabled.
2. Select either a pull-up or pull-down device if PE is active.

Table 3-2 Pin Configuration Summary

DDR	IO	RDR	PE	PS	IE ¹	Function	Pull Device	Interrupt
0	X	X	0	X	0	Input	Disabled	Disabled
0	X	X	1	0	0	Input	Pull Up	Disabled
0	X	X	1	1	0	Input	Pull Down	Disabled
0	X	X	0	0	1	Input	Disabled	falling edge
0	X	X	0	1	1	Input	Disabled	rising edge
0	X	X	1	0	1	Input	Pull Up	falling edge
0	X	X	1	1	1	Input	Pull Down	rising edge
1	0	0	X	X	0	Output, full drive to 0	Disabled	Disabled
1	1	0	X	X	0	Output, full drive to 1	Disabled	Disabled
1	0	1	X	X	0	Output, reduced drive to 0	Disabled	Disabled
1	1	1	X	X	0	Output, reduced drive to 1	Disabled	Disabled
1	0	0	X	0	1	Output, full drive to 0	Disabled	falling edge
1	1	0	X	1	1	Output, full drive to 1	Disabled	rising edge
1	0	1	X	0	1	Output, reduced drive to 0	Disabled	falling edge
1	1	1	X	1	1	Output, reduced drive to 1	Disabled	rising edge

NOTES:

1. Applicable only on port P, H and J.

NOTE: All bits of all registers in this module are completely synchronous to internal clocks during a register read.

3.1.1 Port T Registers

Address Offset: \$_00

	Bit 7	6	5	4	3	2	1	Bit 0
Read:	PTT7	PTT6	PTT5	PTT4	PTT3	PTT2	PTT1	PTT0
Write:								
ECT:	IOC7	IOC6	IOC5	IOC4	IOC3	IOC2	IOC1	IOC0
Reset:	0	0	0	0	0	0	0	0



= Reserved or unimplemented

Figure 3-1 Port T I/O Register (PTT)

Read:Anytime.

Write:Anytime.

If the data direction bits of the associated I/O pins are set to 1, a read returns the value of the port register, otherwise the value at the pins is read.

Address Offset: \$__01

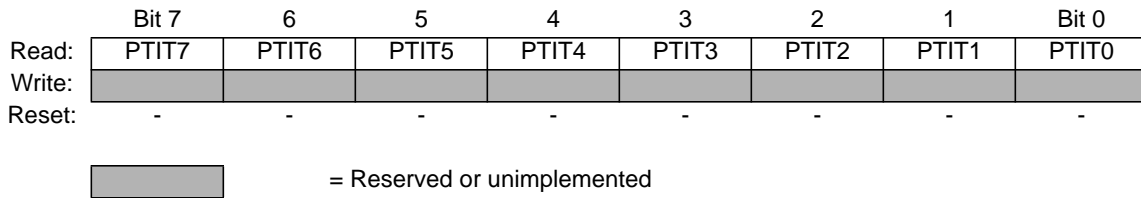

Figure 3-2 Port T Input Register (PTIT)

Read:Anytime.

Write:Never, writes to this register have no effect.

This register always reads back the status of the associated pins. This can also be used to detect overload or short circuit conditions on output pins.

Address Offset: \$__02

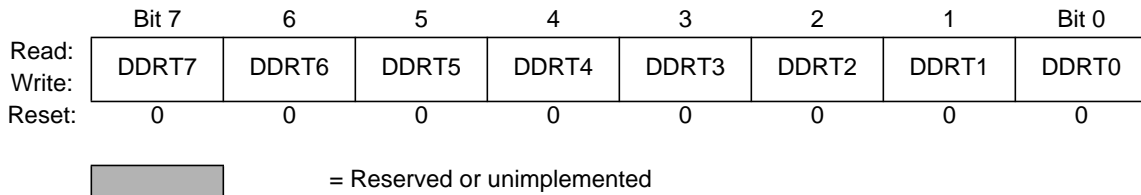

Figure 3-3 Port T Data Direction Register (DDRT)

Read:Anytime.

Write:Anytime.

This register configures each port T pin as either input or output. The ECT forces the I/O state to be an output for each timer port associated with an enabled output compare. In these cases the data direction bits will not change. The DDRT bits revert to controlling the I/O direction of a pin when the associated timer output compare is disabled. The timer input capture always monitors the state of the pin.

- DDRT[7:0] — Data Direction Port T
- 1 = Associated pin is configured as output.
 - 0 = Associated pin is configured as input.

Due to internal synchronization circuits, it can take up to 2 bus cycles until the correct value is read on PTT or PTIT registers, when changing the DDRT register.

Address Offset: \$__03

	Bit 7	6	5	4	3	2	1	Bit 0
Read:	RDRT7	RDRT6	RDRT5	RDRT4	RDRT3	RDRT2	RDRT1	RDRT0
Write:								
Reset:	0	0	0	0	0	0	0	0

 = Reserved or unimplemented

Figure 3-4 Port T Reduced Drive Register (RDRT)

Read:Anytime.

Write:Anytime.

This register configures the drive strength of each port T output pin as either full or reduced. If the port is used as input this bit is ignored.

RDRT[7:0] — Reduced Drive Port T

1 = Associated pin drives at about 1/3 of the full drive strength.

0 = Full drive strength at output.

Address Offset: \$__04

	Bit 7	6	5	4	3	2	1	Bit 0
Read:	PERT7	PERT6	PERT5	PERT4	PERT3	PERT2	PERT1	PERT0
Write:								
Reset:	0	0	0	0	0	0	0	0

 = Reserved or unimplemented

Figure 3-5 Port T Pull Device Enable Register (PERT)

Read:Anytime.

Write:Anytime.

This register configures whether a pull-up or a pull-down device is activated, if the port is used as input. This bit has no effect if the port is used as output. Out of reset no pull device is enabled.

PERT[7:0] — Pull Device Enable Port T

1 = Either a pull-up or pull-down device is enabled.

0 = Pull-up or pull-down device is disabled.

Address Offset: \$__05

	Bit 7	6	5	4	3	2	1	Bit 0
Read:	PPST7	PPST6	PPST5	PPST4	PPST3	PPST2	PPST1	PPST0
Write:								
Reset:	0	0	0	0	0	0	0	0

 = Reserved or unimplemented

Figure 3-6 Port T Polarity Select Register (PPST)

Read:Anytime.

Write:Anytime.

This register selects whether a pull-down or a pull-up device is connected to the pin.

PPST[7:0] — Pull Select Port T

- 1 = A pull-down device is connected to the associated port T pin, if enabled by the associated bit in register PERT and if the port is used as input.
- 0 = A pull-up device is connected to the associated port T pin, if enabled by the associated bit in register PERT and if the port is used as input.

3.1.2 Port S Registers

Address Offset: \$__08

	Bit 7	6	5	4	3	2	1	Bit 0
Read:	PTS7	PTS6	PTS5	PTS4	PTS3	PTS2	PTS1	PTS0
Write:								
SPI/SCI	SS0	SCK0	MOSI0	MISO0	TXD1	RXD1	TXD0	RXD0
Reset:	0	0	0	0	0	0	0	0

 = Reserved or unimplemented

Figure 3-7 Port S I/O Register (PTS)

Read:Anytime.

Write:Anytime.

If the data direction bits of the associated I/O pins are set to 1, a read returns the value of the port register, otherwise the value at the pins is read.

The SPI pins (PS[7:4]) configuration is determined by several status bits in the SPI module. *Refer to SPI Block Guide for details.*

The SCI ports associated with transmit pins 3 and 1 are configured as outputs if the transmitter is enabled. The SCI ports associated with receive pins 2 and 0 are configured as inputs if the receiver is enabled. *Refer to SCI Block Guide for details.*

Address Offset: \$__09

	Bit 7	6	5	4	3	2	1	Bit 0
Read:	PTIS7	PTIS6	PTIS5	PTIS4	PTIS3	PTIS2	PTIS1	PTIS0
Write:								
Reset:	-	-	-	-	-	-	-	-



= Reserved or unimplemented

Figure 3-8 Port S Input Register (PTIS)

Read:Anytime.

Write:Never, writes to this register have no effect.

This register always reads back the status of the associated pins. This also can be used to detect overload or short circuit conditions on output pins.

Address Offset:\$__0A

	Bit 7	6	5	4	3	2	1	Bit 0
Read:	DDRS7	DDRS6	DDRS5	DDRS4	DDRS3	DDRS2	DDRS1	DDRS0
Write:								
Reset:	0	0	0	0	0	0	0	0



= Reserved or unimplemented

Figure 3-9 Port S Data Direction Register (DDRS)

Read:Anytime.

Write:Anytime.

This register configures each port S pin as either input or output

If SPI is enabled, the SPI determines the pin direction. *Refer to SPI Block Guide for details.*

If the associated SCI transmit or receive channel is enabled this register has no effect on the pins. The pin is forced to be an output if a SCI transmit channel is enabled, it is forced to be an input if the SCI receive channel is enabled.

The DDRS bits revert to controlling the I/O direction of a pin when the associated channel is disabled.

DDRS[7:0] — Data Direction Port S

1 = Associated pin is configured as output.

0 = Associated pin is configured as input.

Due to internal synchronization circuits, it can take up to 2 bus cycles until the correct value is read on PTS or PTIS registers, when changing the DDRS register.

Address Offset: \$__0B

	Bit 7	6	5	4	3	2	1	Bit 0
Read:	RDRS7	RDRS6	RDRS5	RDRS4	RDRS3	RDRS2	RDRS1	RDRS0
Write:								
Reset:	0	0	0	0	0	0	0	0

 = Reserved or unimplemented

Figure 3-10 Port S Reduced Drive Register (RDRS)

Read:Anytime.

Write:Anytime.

This register configures the drive strength of each port S output pin as either full or reduced. If the port is used as input this bit is ignored.

RDRS[7:0] — Reduced Drive Port S

1 = Associated pin drives at about 1/3 of the full drive strength.

0 = Full drive strength at output.

Address Offset: \$__0C

	Bit 7	6	5	4	3	2	1	Bit 0
Read:	PERS7	PERS6	PERS5	PERS4	PERS3	PERS2	PERS1	PERS0
Write:								
Reset:	1	1	1	1	1	1	1	1

 = Reserved or unimplemented

Figure 3-11 Port S Pull Device Enable Register (PERS)

Read:Anytime.

Write:Anytime.

This register configures whether a pull-up or a pull-down device is activated, if the port is used as input or as output in wired-or (open drain) mode. This bit has no effect if the port is used as push-pull output. Out of reset a pull-up device is enabled.

PERS[7:0] — Pull Device Enable Port S

1 = Either a pull-up or pull-down device is enabled.

0 = Pull-up or pull-down device is disabled.

Address Offset: \$__0D

	Bit 7	6	5	4	3	2	1	Bit 0
Read:	PPSS7	PPSS6	PPSS5	PPSS4	PPSS3	PPSS2	PPSS1	PPSS0
Write:								
Reset:	0	0	0	0	0	0	0	0



= Reserved or unimplemented

Figure 3-12 Port S Polarity Select Register (PPSS)

Read:Anytime.

Write:Anytime.

This register selects whether a pull-down or a pull-up device is connected to the pin.

PPSS[7:0] — Pull Select Port S

1 = A pull-down device is connected to the associated port S pin, if enabled by the associated bit in register PERS and if the port is used as input.

0 = A pull-up device is connected to the associated port S pin, if enabled by the associated bit in register PERS and if the port is used as input or as wired-or output.

Address Offset: \$__0E

	Bit 7	6	5	4	3	2	1	Bit 0
Read:	WOMS7	WOMS6	WOMS5	WOMS4	WOMS3	WOMS2	WOMS1	WOMS0
Write:								
Reset:	0	0	0	0	0	0	0	0



= Reserved or unimplemented

Figure 3-13 Port S Wired-Or Mode Register (WOMS)

Read:Anytime.

Write:Anytime.

This register configures the output pins as wired-or. If enabled the output is driven active low only (open-drain). A logic level of “1” is not driven. It applies also to the SPI and SCI outputs and allows a multipoint connection of several serial modules. This bit has no influence on pins used as inputs.

WOMS[7:0] — Wired-Or Mode Port S

1 = Output buffers operate as open-drain outputs.

0 = Output buffers operate as push-pull outputs.

3.1.3 Port M Registers

Address Offset: \$__10

	Bit 7	6	5	4	3	2	1	Bit 0
Read:	PTM7	PTM6	PTM5	PTM4	PTM3	PTM2	PTM1	PTM0
Write:								
CAN:					TXCAN1	RXCAN1	TXCAN0	RXCAN0
CAN0:			TXCAN0	RXCAN0	TXCAN0	RXCAN0		
CAN4:	TXCAN4	RXCAN4	TXCAN4	RXCAN4				
SPI0:			SCK0	MOSI0	SS0	MISO0		
Reset	0	0	0	0	0	0	0	0

 = Reserved or unimplemented

Figure 3-14 Port M I/O Register (PTM)

Read:Anytime.

Write:Anytime.

If the data direction bits of the associated I/O pins are set to 1, a read returns the value of the port register, otherwise the value at the pins is read.

PM[7:6]

The CAN4 function (TXCAN4 and RXCAN4) takes precedence over the general purpose I/O function if the CAN4 module is enabled. *Refer to MSCAN Block Guide for details.*

PM[5:4]

The CAN0 function (TXCAN0 and RXCAN0) takes precedence over the CAN4, the SPI0 and the general purpose I/O function if the CAN0 module is enabled.

The CAN4 function (TXCAN4 and RXCAN4) takes precedence over the SPI and general purpose I/O function if the CAN4 module is enabled. *Refer to MSCAN Block Guide for details.*

The SPI0 function (SCK0 and MOSI0) takes precedence of the general purpose I/O function if the SPI0 is enabled. *Refer to SPI Block Guide for details.*

PM[3:2]

The CAN1 function (TXCAN1 and RXCAN1) takes precedence over the CAN0, the SPI0 and the general purpose I/O function if the CAN1 module is enabled.

The CAN0 function (TXCAN0 and RXCAN0) takes precedence over the SPI0 and the general purpose I/O function if the CAN0 module is enabled. *Refer to MSCAN Block Guide for details.*

The SPI0 function (SS0 and MISO0) takes precedence of the general purpose I/O function if the SPI0 is enabled and not in bidirectional mode. *Refer to SPI Block Guide for details.*

PM[1:0]

The CAN0 function (TXCAN0 and RXCAN0) takes precedence over the general purpose I/O function if the CAN0 module is enabled. Refer to *MSCAN Block Guide for details*.

Address Offset: \$__11

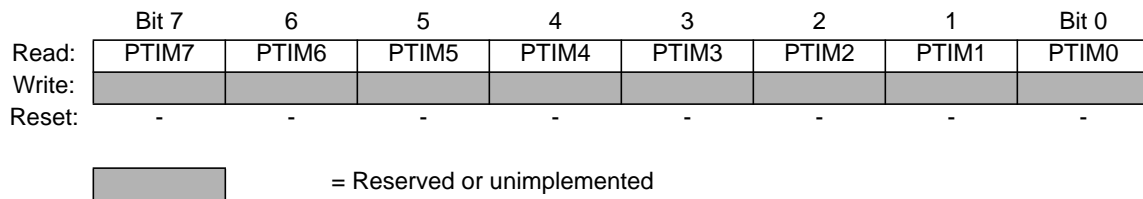

Figure 3-15 Port M Input Register (PTIM)

Read:Anytime.

Write:Never, writes to this register have no effect.

This register always reads back the status of the associated pins. This can also be used to detect overload or short circuit conditions on output pins.

Address Offset: \$__12

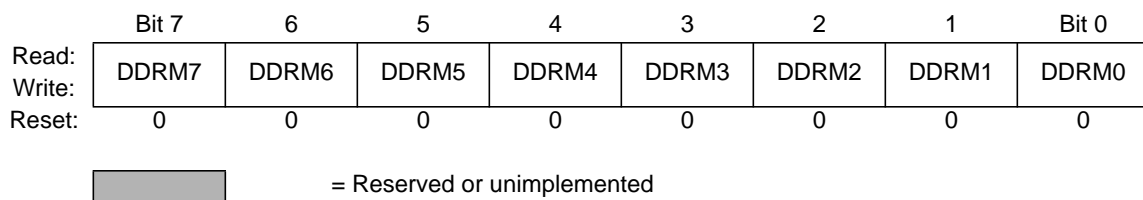

Figure 3-16 Port M Data Direction Register (DDRM)

Read:Anytime.

Write:Anytime.

This register configures each port M pin as either input or output.

The CAN forces the I/O state to be an output for each port line associated with an enabled output (TXCAN[1:0]). It also forces the I/O state to be an input for each port line associated with an enabled input (RXCAN[1:0]). In those cases the data direction bits will not change.

The DDRM bits revert to controlling the I/O direction of a pin when the associated peripheral module is disabled.

DDRM[7:0] — Data Direction Port M

1 = Associated pin is configured as output.

0 = Associated pin is configured as input.

Due to internal synchronization circuits, it can take up to 2 bus cycles until the correct value is read on PTM or PTIM registers, when changing the DDRM register.

Address Offset: \$__13

	Bit 7	6	5	4	3	2	1	Bit 0
Read:	RDRM7	RDRM6	RDRM5	RDRM4	RDRM3	RDRM2	RDRM1	RDRM0
Write:								
Reset:	0	0	0	0	0	0	0	0

 = Reserved or unimplemented

Figure 3-17 Port M Reduced Drive Register (RDRM)

Read:Anytime.

Write:Anytime.

This register configures the drive strength of each port M output pin as either full or reduced. If the port is used as input this bit is ignored.

RDRM[7:0] — Reduced Drive Port M

1 = Associated pin drives at about 1/3 of the full drive strength.

0 = Full drive strength at output.

Address Offset: \$__14

	Bit 7	6	5	4	3	2	1	Bit 0
Read:	PERM7	PERM6	PERM5	PERM4	PERM3	PERM2	PERM1	PERM0
Write:								
Reset:	0	0	0	0	0	0	0	0

 = Reserved or unimplemented

Figure 3-18 Port M Pull Device Enable Register (PERM)

Read:Anytime.

Write:Anytime.

This register configures whether a pull-up or a pull-down device is activated, if the port is used as input or wired-or output. This bit has no effect if the port is used as push-pull output. Out of reset no pull device is enabled.

PERM[7:0] — Pull Device Enable Port M

1 = Either a pull-up or pull-down device is enabled.

0 = Pull-up or pull-down device is disabled.

Address Offset: \$__15

	Bit 7	6	5	4	3	2	1	Bit 0
Read:	PPSM7	PPSM6	PPSM5	PPSM4	PPSM3	PPSM2	PPSM1	PPSM0
Write:								
Reset:	0	0	0	0	0	0	0	0

 = Reserved or unimplemented

Figure 3-19 Port M Polarity Select Register (PPSM)

Read:Anytime.

Write:Anytime.

This register selects whether a pull-down or a pull-up device is connected to the pin. If CAN is active a pull-up device can be activated on the RXCAN[1:0] inputs, but not a pull-down.

PPSM[7:0] — Pull Select Port M

1 = A pull-down device is connected to the associated port M pin, if enabled by the associated bit in register PERM and if the port is used as a general purpose but not as RXCAN.

0 = A pull-up device is connected to the associated port M pin, if enabled by the associated bit in register PERM and if the port is used as general purpose or RXCAN input.

Address Offset: \$__16

	Bit 7	6	5	4	3	2	1	Bit 0
Read:	WOMM7	WOMM6	WOMM5	WOMM4	WOMM3	WOMM2	WOMM1	WOMM0
Write:								
Reset:	0	0	0	0	0	0	0	0

 = Reserved or unimplemented

Figure 3-20 Port M Wired-Or Mode Register (WOMM)

Read:Anytime.

Write:Anytime.

This register configures the output pins as wired-or. If enabled the output is driven active low only (open-drain). A logic level of “1” is not driven. It applies also to the CAN outputs and allows a multipoint connection of several serial modules. This bit has no influence on pins used as inputs.

WOMM[7:0] — Wired-Or Mode Port M

1 = Output buffers operate as open-drain outputs.

0 = Output buffers operate as push-pull outputs.

Address Offset: \$__17

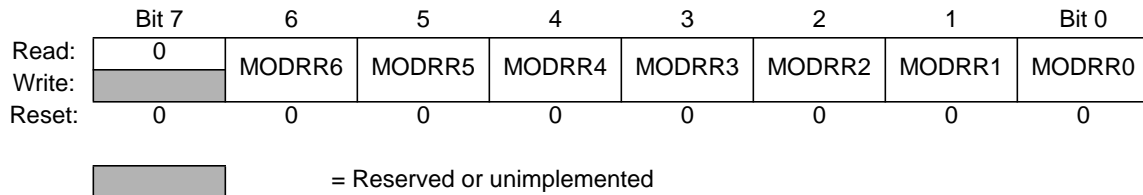

Figure 3-21 Module Routing Register (MODRR)

Read:Anytime.

Write:Anytime.

This register configures the re-routing of CAN0, CAN4, SPI0, SPI1, and SPI2 on defined port pins.

MODRR[1:0] — CAN0 Routing

Table 3-3 CAN0 Routing

MODRR[1]	MODRR[0]	RXCAN0	TXCAN0
0	0	PM0	PM1
0	1	PM2	PM3
1	0	PM4	PM5
1	1	PJ6	PJ7

MODRR[3:2] — CAN4 Routing

Table 3-4 CAN4 Routing

MODRR[3]	MODRR[2]	RXCAN4	TXCAN4
0	0	PJ6	PJ7
0	1	PM4	PM5
1	0	PM6	PM7
1	1	Reserved	

MODRR[4] — SPI0 Routing

Table 3-5 SPI0 Routing

MODRR[4]	MISO0	MOSI0	SCK0	SS0
0	PS4	PS5	PS6	PS7
1	PM2	PM4	PM5	PM3

MODRR[5] — SPI1 Routing

Table 3-6 SPI1 Routing

MODRR[5]	MISO1	MOSI1	SCK1	SS1
0	PP0	PP1	PP2	PP3
1	PH0	PH1	PH2	PH3

MODRR[6] — SPI2 Routing

Table 3-7 SPI2 Routing

MODRR[6]	MISO2	MOSI2	SCK2	SS2
0	PP4	PP5	PP7	PP6
1	PH4	PH5	PH6	PH7

3.1.4 Port P Registers

Address Offset: \$__18

	Bit 7	6	5	4	3	2	1	Bit 0
Read:	PTP7	PTP6	PTP5	PTP4	PTP3	PTP2	PTP1	PTP0
Write:	PTP7	PTP6	PTP5	PTP4	PTP3	PTP2	PTP1	PTP0
PWM:	PWM7	PWM6	PWM5	PWM4	PWM3	PWM2	PWM1	PWM0
SPI:	SCK2	SS2	MOSI2	MISO2	SS1	SCK1	MOSI1	MISO1
Reset:	0	0	0	0	0	0	0	0

 = Reserved or unimplemented

Figure 3-22 Port P I/O Register (PTP)

Read:Anytime.

Write:Anytime.









If the data direction bits of the associated I/O pins are set to 1, a read returns the value of the port register, otherwise the value at the pins is read.

The PWM function takes precedence over the general purpose I/O function if the associated PWM channel is enabled. While channels 6-0 are output only if the respective channel is enabled, channel 7 can be PWM output or input if the shutdown feature is enabled. *Refer to PWM Block Guide for details.*

The SPI function takes precedence over the general purpose I/O function associated with if enabled. *Refer to SPI Block Guide for details.*

If both PWM and SPI are enabled the PWM functionality takes precedence.

Address Offset: \$__19

	Bit 7	6	5	4	3	2	1	Bit 0
Read:	PTIP7	PTIP6	PTIP5	PTIP4	PTIP3	PTIP2	PTIP1	PTIP0
Write:								
Reset:	-	-	-	-	-	-	-	-

 = Reserved or unimplemented

Figure 3-23 Port P Input Register (PTIP)

Read:Anytime.

Write:Never, writes to this register have no effect.

This register always reads back the status of the associated pins. This can be also used to detect overload or short circuit conditions on output pins.

Address Offset: \$__1A

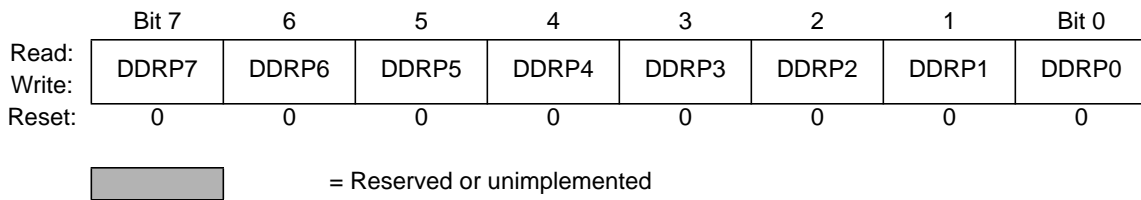

Figure 3-24 Port P Data Direction Register (DDRP)

Read:Anytime.

Write:Anytime.

This register configures each port P pin as either input or output.

If the associated PWM channel or SPI module is enabled this register has no effect on the pins.

The PWM forces the I/O state to be an output for each port line associated with an enabled PWM7-0 channel. Channel 7 can force the pin to input if the shutdown feature is enabled.

If a SPI module is enabled, the SPI determines the pin direction. *Refer to SPI Block Guide for details.*

The DDRM bits revert to controlling the I/O direction of a pin when the associated PWM channel is disabled.

DDRP[7:0] — Data Direction Port P

1 = Associated pin is configured as output.

0 = Associated pin is configured as input.

Due to internal synchronization circuits, it can take up to 2 bus cycles until the correct value is read on PTP or PTIP registers, when changing the DDRP register.

Address Offset: \$__1B



Figure 3-25 Port P Reduced Drive Register (RDRP)

Read:Anytime.

Write:Anytime.

This register configures the drive strength of each port P output pin as either full or reduced. If the port is used as input this bit is ignored.

RDRP[7:0] — Reduced Drive Port P

1 = Associated pin drives at about 1/3 of the full drive strength.

0 = Full drive strength at output.

Address Offset: \$__1C

	Bit 7	6	5	4	3	2	1	Bit 0
Read:	PERP7	PERP6	PERP5	PERP4	PERP3	PERP2	PERP1	PERP0
Write:								
Reset:	0	0	0	0	0	0	0	0

 = Reserved or unimplemented

Figure 3-26 Port P Pull Device Enable Register (PERP)

Read:Anytime.

Write:Anytime.

This register configures whether a pull-up or a pull-down device is activated, if the port is used as input. This bit has no effect if the port is used as output. Out of reset no pull device is enabled.

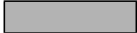
PERP[7:0] — Pull Device Enable Port P

1 = Either a pull-up or pull-down device is enabled.

0 = Pull-up or pull-down device is disabled.

Address Offset: \$__1D

	Bit 7	6	5	4	3	2	1	Bit 0
Read:	PPSP7	PPSP6	PPSP5	PPSP4	PPSP3	PPSP2	PPSP1	PPSP0
Write:								
Reset:	0	0	0	0	0	0	0	0

 = Reserved or unimplemented

Figure 3-27 Port P Polarity Select Register (PPSP)

Read:Anytime.

Write:Anytime.

This register serves a dual purpose by selecting the polarity of the active interrupt edge as well as selecting a pull-up or pull-down device if enabled.

PPSP[7:0] — Polarity Select Port P

1 = Rising edge on the associated port P pin sets the associated flag bit in the PIFP register. A pull-down device is connected to the associated port P pin, if enabled by the associated bit in register PERP and if the port is used as input.

0 = Falling edge on the associated port P pin sets the associated flag bit in the PIFP register. A pull-up device is connected to the associated port P pin, if enabled by the associated bit in register PERP and if the port is used as input.

Address Offset: \$__1E

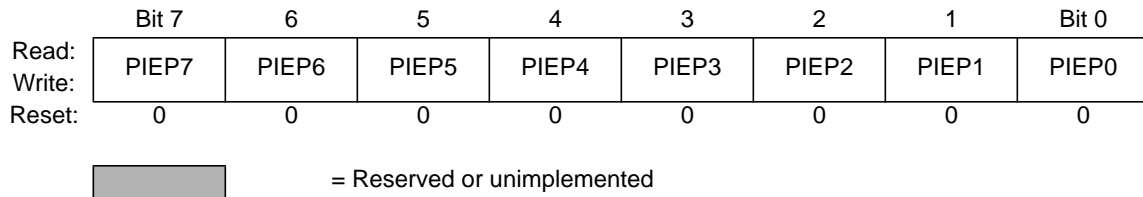

Figure 3-28 Port P Interrupt Enable Register (PIEP)

Read:Anytime.

Write:Anytime.

This register disables or enables on a per pin basis the edge sensitive external interrupt associated with port P.

PIEP[7:0] — Interrupt Enable Port P

1 = Interrupt is enabled.

0 = Interrupt is disabled (interrupt flag masked).

Address Offset: \$__1F

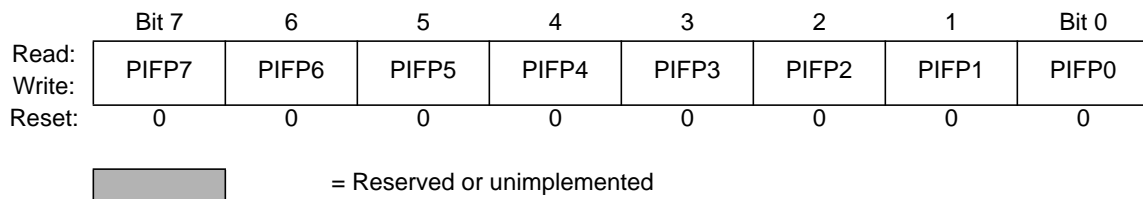

Figure 3-29 Port P Interrupt Flag Register (PIFP)

Read:Anytime.

Write:Anytime.

Each flag is set by an active edge on the associated input pin. This could be a rising or a falling edge based on the state of the PPSP register. To clear this flag, write “1” to the corresponding bit in the PIFP register. Writing a “0” has no effect.

PIFP[7:0] — Interrupt Flags Port P

1 = Active edge on the associated bit has occurred (an interrupt will occur if the associated enable bit is set).

Writing a “1” clears the associated flag.

0 = No active edge pending.

Writing a “0” has no effect.

3.1.5 Port H Registers

Address Offset: \$__20

	Bit 7	6	5	4	3	2	1	Bit 0
Read:	PTH7	PTH6	PTH5	PTH4	PTH3	PTH2	PTH1	PTH0
Write:	SS2	SCK2	MOSI2	MISO2	SS1	SCK1	MOSI1	MISO1
Reset:	0	0	0	0	0	0	0	0

 = Reserved or unimplemented

Figure 3-30 Port H I/O Register (PTH)









Read:Anytime.

Write:Anytime.

If the data direction bits of the associated I/O pins are set to 1, a read returns the value of the port register, otherwise the value at the pins is read.

The SPI function takes precedence over the general purpose I/O function associated with if enabled. *Refer to SPI Block Guide for details.*

Address Offset: \$__21

	Bit 7	6	5	4	3	2	1	Bit 0
Read:	PTIH7	PTIH6	PTIH5	PTIH4	PTIH3	PTIH2	PTIH1	PTIH0
Write:								
Reset:	-	-	-	-	-	-	-	-

 = Reserved or unimplemented

Figure 3-31 Port H Input Register (PTIH)

Read:Anytime.

Write:Never, writes to this register have no effect.

This register always reads back the status of the associated pins. This can also be used to detect overload or short circuit conditions on output pins.

Address Offset: \$ _22

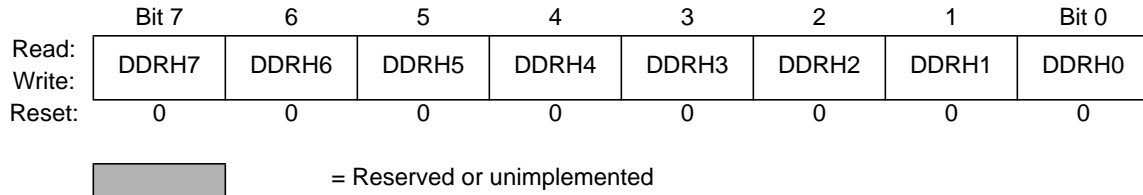

Figure 3-32 Port H Data Direction Register (DDRH)

Read:Anytime.

Write:Anytime.

This register configures each port H pin as either input or output.

DDRH[7:0] — Data Direction Port H

1 = Associated pin is configured as output.

0 = Associated pin is configured as input.

Due to internal synchronization circuits, it can take up to 2 bus cycles until the correct value is read on PTH or PTIH registers, when changing the DDRH register.

Address Offset: \$ _23



Figure 3-33 Port H Reduced Drive Register (RDRH)

Read:Anytime.

Write:Anytime.

This register configures the drive strength of each port H output pin as either full or reduced. If the port is used as input this bit is ignored.

RDRH[7:0] — Reduced Drive Port H

1 = Associated pin drives at about 1/3 of the full drive strength.

0 = Full drive strength at output.

Address Offset: \$ _24

	Bit 7	6	5	4	3	2	1	Bit 0
Read:	PERH7	PERH6	PERH5	PERH4	PERH3	PERH2	PERH1	PERH0
Write:								
Reset:	0	0	0	0	0	0	0	0

 = Reserved or unimplemented

Figure 3-34 Port H Pull Device Enable Register (PERH)

Read:Anytime.

Write:Anytime.

This register configures whether a pull-up or a pull-down device is activated, if the port is used as input. This bit has no effect if the port is used as output. Out of reset no pull device is enabled.

PERH[7:0] — Pull Device Enable Port H

1 = Either a pull-up or pull-down device is enabled.

0 = Pull-up or pull-down device is disabled.

Address Offset: \$ _25

	Bit 7	6	5	4	3	2	1	Bit 0
Read:	PPSH7	PPSH6	PPSH5	PPSH4	PPSH3	PPSH2	PPSH1	PPSH0
Write:								
Reset:	0	0	0	0	0	0	0	0

 = Reserved or unimplemented

Figure 3-35 Port H Polarity Select Register (PPSH)

Read:Anytime.

Write:Anytime.

This register serves a dual purpose by selecting the polarity of the active interrupt edge as well as selecting a pull-up or pull-down device if enabled.

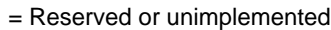
PPSH[7:0] — Polarity Select Port H

1 = Rising edge on the associated port H pin sets the associated flag bit in the PIFH register.

A pull-down device is connected to the associated port H pin, if enabled by the associated bit in register PERH and if the port is used as input.

0 = Falling edge on the associated port H pin sets the associated flag bit in the PIFH register.

A pull-up device is connected to the associated port H pin, if enabled by the associated bit in register PERH and if the port is used as input.

Address Offset: \$__26

	Bit 7	6	5	4	3	2	1	Bit 0
Read:	PIEH7	PIEH6	PIEH5	PIEH4	PIEH3	PIEH2	PIEH1	PIEH0
Write:								
Reset:	0	0	0	0	0	0	0	0

 = Reserved or unimplemented

Figure 3-36 Port H Interrupt Enable Register (PIEH)

Read:Anytime.

Write:Anytime.

This register disables or enables on a per pin basis the edge sensitive external interrupt associated with port H.

PIEH[7:0] — Interrupt Enable Port H

1 = Interrupt is enabled.

0 = Interrupt is disabled (interrupt flag masked).

Address Offset: \$__27

	Bit 7	6	5	4	3	2	1	Bit 0
Read:	PIFH7	PIFH6	PIFH5	PIFH4	PIFH3	PIFH2	PIFH1	PIFH0
Write:								
Reset:	0	0	0	0	0	0	0	0

 = Reserved or unimplemented

Figure 3-37 Port H Interrupt Flag Register (PIFH)

Read:Anytime.

Write:Anytime.

Each flag is set by an active edge on the associated input pin. This could be a rising or a falling edge based on the state of the PPSH register. To clear this flag, write “1” to the corresponding bit in the PIFH register. Writing a “0” has no effect.

PIFH[7:0] — Interrupt Flags Port H

1 = Active edge on the associated bit has occurred (an interrupt will occur if the associated enable bit is set).

Writing a “1” clears the associated flag.

0 = No active edge pending.

Writing a “0” has no effect.

3.1.6 Port J Registers

Address Offset: \$ _28

	Bit 7	6	5	4	3	2	1	Bit 0
Read:	PTJ7	PTJ6	0	0	0	0	PTJ1	PTJ0
Write:								
CAN4:	TXCAN4	RXCAN4						
IIC:	SCL	SDA						
CAN0:	TXCAN0	RXCAN0						
Reset:	0	0	-	-	-	-	0	0

 = Reserved or unimplemented

Figure 3-38 Port J I/O Register (PTJ)

Read:Anytime.

Write:Anytime.

If the data direction bits of the associated I/O pins are set to 1, a read returns the value of the port register, otherwise the value at the pins is read.

PJ[7:6]

The CAN4 function (TXCAN4 and RXCAN4) takes precedence over the IIC, the CAN0 and the general purpose I/O function if the CAN4 module is enabled.

The IIC function (SCL and SDA) takes precedence over CAN0 and the general purpose I/O function if the IIC is enabled. If the IIC module takes precedence the SDA and SCL outputs are configured as open drain outputs. *Refer to IIC Block Guide for details.*

The CAN0 function (TXCAN0 and RXCAN0) takes precedence over the general purpose I/O function if the CAN0 module is enabled. *Refer to MSCAN Block Guide for details.*

Address Offset: \$ _29

	Bit 7	6	5	4	3	2	1	Bit 0
Read:	PTIJ7	PTIJ6	0	0	0	0	PTIJ1	PTIJ0
Write:								
Reset:	-	-	-	-	-	-	-	-

 = Reserved or unimplemented

Figure 3-39 Port J Input Register (PTIJ)

Read:Anytime.

Write:Never, writes to this register have no effect.

This register always reads back the status of the associated pins. This can be used to detect overload or short circuit conditions on output pins.

Address Offset: \$ _2A

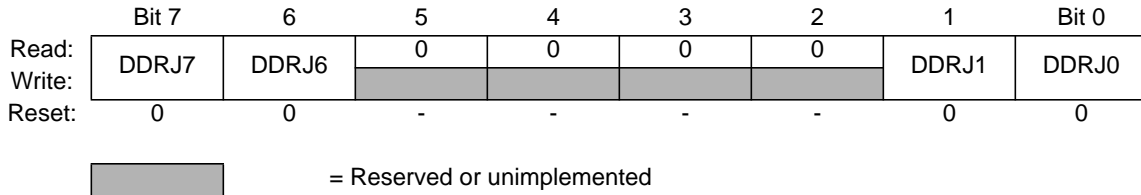

Figure 3-40 Port J Data Direction Register (DDRJ)

Read:Anytime.

Write:Anytime.

This register configures each port J pin as either input or output. The CAN forces the I/O state to be an output on PJ7 (TXCAN4) and an input on pin PJ6 (RXCAN4). The IIC takes control of the I/O if enabled. In these cases the data direction bits will not change. The DDRJ bits revert to controlling the I/O direction of a pin when the associated peripheral module is disabled.

DDRJ[7:6][1:0] — Data Direction Port J

- 1 = Associated pin is configured as output.
- 0 = Associated pin is configured as input.

Due to internal synchronization circuits, it can take up to 2 bus cycles until the correct value is read on PTJ or PTIJ registers, when changing the DDRJ register.

Address Offset: \$ _2B

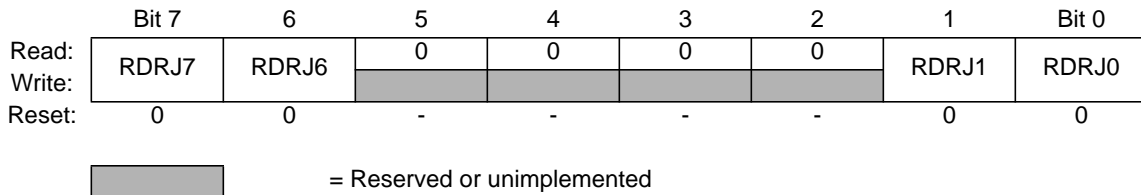

Figure 3-41 Port J Reduced Drive Register (RDRJ)

Read:Anytime.

Write:Anytime.

This register configures the drive strength of each port J output pin as either full or reduced. If the port is used as input this bit is ignored.

RDRJ[7:6][1:0] — Reduced Drive Port J

- 1 = Associated pin drives at about 1/3 of the full drive strength.
- 0 = Full drive strength at output.

Address Offset: \$ _2C

	Bit 7	6	5	4	3	2	1	Bit 0
Read:	PERJ7	PERJ6	0	0	0	0	PERJ1	PERJ0
Write:								
Reset:	1	1	-	-	-	-	1	1

= Reserved or unimplemented

Figure 3-42 Port J Pull Device Enable Register (PERJ)

Read:Anytime.

Write:Anytime.

This register configures whether a pull-up or a pull-down device is activated, if the port is used as input or as wired-or output. This bit has no effect if the port is used as push-pull output. Out of reset a pull-up device is enabled.

PERJ[7:6][1:0] — Pull Device Enable Port J

1 = Either a pull-up or pull-down device is enabled.

0 = Pull-up or pull-down device is disabled.

Address Offset: \$ _2D

	Bit 7	6	5	4	3	2	1	Bit 0
Read:	PPSJ7	PPSJ6	0	0	0	0	PPSJ1	PPSJ0
Write:								
Reset:	0	0	-	-	-	-	0	0

= Reserved or unimplemented

Figure 3-43 Port J Polarity Select Register (PPSJ)

Read:Anytime.

Write:Anytime.

This register serves a dual purpose by selecting the polarity of the active interrupt edge as well as selecting a pull-up or pull-down device if enabled.

PPSJ[7:6][1:0] — Polarity Select Port J

1 = Rising edge on the associated port J pin sets the associated flag bit in the PIFJ register.

A pull-down device is connected to the associated port J pin, if enabled by the associated bit in register PERJ and if the port is used as input.

0 = Falling edge on the associated port J pin sets the associated flag bit in the PIFJ register.

A pull-up device is connected to the associated port J pin, if enabled by the associated bit in register PERJ and if the port is used as general purpose input or as IIC port.

Address Offset: \$_2E

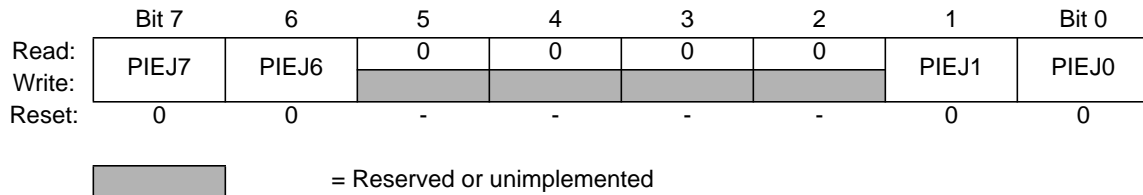

Figure 3-44 Port J Interrupt Enable Register (PIEJ)

Read:Anytime.

Write:Anytime.

This register disables or enables on a per pin basis the edge sensitive external interrupt associated with port J.

PIEJ[7:6][1:0] — Interrupt Enable Port J

1 = Interrupt is enabled.

0 = Interrupt is disabled (interrupt flag masked).

Address Offset: \$_2F

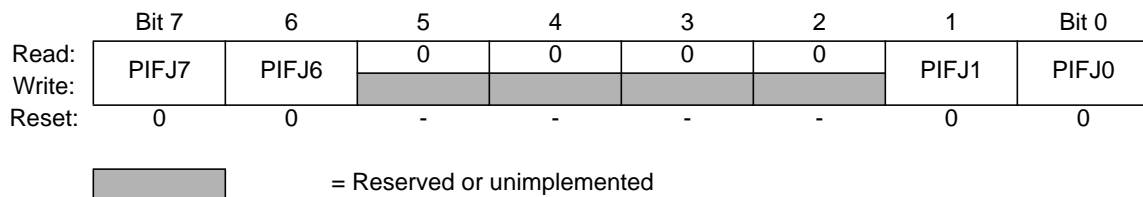

Figure 3-45 Port J Interrupt Flag Register (PIFJ)

Read:Anytime.

Write:Anytime.

Each flag is set by an active edge on the associated input pin. This could be a rising or a falling edge based on the state of the PPSJ register. To clear this flag, write “1” to the corresponding bit in the PIFJ register. Writing a “0” has no effect.

PIFJ[7:6][1:0] — Interrupt Flags Port J

1 = Active edge on the associated bit has occurred (an interrupt will occur if the associated enable bit is set).

Writing a “1” clears the associated flag.

0 = No active edge pending.

Writing a “0” has no effect.

Section 4 Functional Description

4.1 General

Each pin can act as general purpose I/O. In addition the pin can act as an output from a peripheral module or an input to a peripheral module.

A set of configuration registers is common to all ports. All registers can be written at any time, however a specific configuration might not become active.

Example:

Selecting a pull-up resistor. This resistor does not become active while the port is used as a push-pull output.

4.1.1 I/O register

This register holds the value driven out to the pin if the port is used as a general purpose I/O.

Writing to this register has only an effect on the pin if the port is used as general purpose output. When reading this address, the value of the pins is returned if the data direction register bits are set to 0.

If the data direction register bits are set to 1, the contents of the I/O register is returned. This is independent of any other configuration (**Figure 4-1**).

4.1.2 Input register

This is a read-only register and always returns the value of the pin (**Figure 4-1**).

4.1.3 Data direction register

This register defines whether the pin is used as an input or an output.

If a peripheral module controls the pin the contents of the data direction register is ignored (**Figure 4-1**).

4.3 Port S

This port is associated with SCI0, SCI1 and SPI0.

Port S pins PS[7:0] can be used either for general-purpose I/O, or with the SCI and SPI subsystems.

During reset, port S pins are configured as inputs with pull-up.

The SPI0 pins can be re-routed. Refer to **Figure 3-21**.

4.4 Port M

This port is associated with CAN4-0 and SPI0.

Port M pins PM[7:0] can be used for either general purpose I/O, or with the CAN and SPI subsystems.

During reset, port M pins are configured as high-impedance inputs.

The CAN0, CAN4 and SPI0 pins can be re-routed. Refer to **Figure 3-21**.

4.4.1 Module Routing Register

This register allows to re-route the CAN0, CAN4, SPI0, SPI1, and SPI2 pins to predefined pins.

NOTE: *The purpose of the Module Routing Register is to provide maximum flexibility for future derivatives of the MC9S12DP256 with a lower number of MSCAN and SPI modules.*

Table 4-1 Implemented modules on derivatives

Number of modules	MSCAN modules				SPI modules		
	CAN0	CAN1	CAN2	CAN4	SPI0	SPI1	SPI2
4	X	X	X	X	-	-	-
3	X	X	-	X	X	X	X
2	X	-	-	X	X	X	-
1	X	-	-	-	X	-	-

4.5 Port P

This port is associated with the PWM, SPI1 and SPI2.

Port P pins PP[7:0] can be used for either general purpose I/O, or with the PWM and SPI subsystems.

The pins are shared between the PWM channels and the SPI1 and SPI2 modules. If the PWM is enabled the pins become PWM output channels with the exception of pin 7 which can be PWM input or output. If

SPI1 or SPI2 are enabled and PWM is disabled, the respective pin configuration is determined by several status bits in the SPI modules.

During reset, port P pins are configured as high-impedance inputs.

The SPI1 and SPI2 pins can be re-routed. Refer to **Figure 3-21**.

Port P offers 8 I/O pins with edge triggered interrupt capability in wired-or fashion. The interrupt enable as well as the sensitivity to rising or falling edges can be individually configured on per pin basis. All 8 bits/pins share the same interrupt vector. Interrupts can be used with the pins configured as inputs or outputs.

An interrupt is generated when a bit in the port interrupt flag register and its corresponding port interrupt enable bit are both set. This external interrupt feature is capable to wake up the CPU when it is in STOP or WAIT mode.

A digital filter on each pin prevents pulses (**Figure 4-3**) shorter than a specified time from generating an interrupt. The minimum time varies over process conditions, temperature and voltage (**Figure 4-2** and **Table 4-2**).

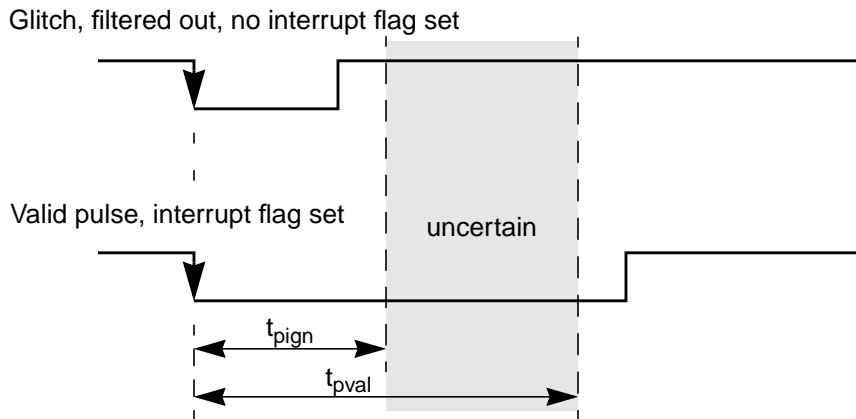

Figure 4-2 Interrupt Glitch Filter on Port P, H and J (PPS=0)

Table 4-2 Pulse Detection Criteria

Pulse	Mode		
	$\overline{\text{STOP}}$		STOP^1
		Unit	
Ignored	$t_{\text{pulse}} \leq 3$	bus clocks	$t_{\text{pulse}} \leq t_{\text{pign}}$
Uncertain	$3 < t_{\text{pulse}} < 4$	bus clocks	$t_{\text{pign}} < t_{\text{pulse}} < t_{\text{pval}}$
Valid	$t_{\text{pulse}} \geq 4$	bus clocks	$t_{\text{pulse}} \geq t_{\text{pval}}$

NOTES:

1. These values include the spread of the oscillator frequency over temperature, voltage and process.

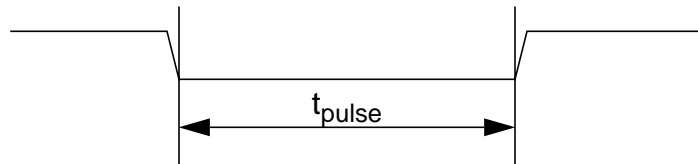

Figure 4-3 Pulse Illustration

A valid edge on an input is detected if 4 consecutive samples of a passive level are followed by 4 consecutive samples of an active level directly or indirectly.

The filters are continuously clocked by the bus clock in RUN and WAIT mode. In STOP mode the clock is generated by a single RC oscillator in the Port Integration Module. To maximize current saving the RC oscillator runs only if the following condition is true on any pin:

Sample count ≤ 4 and port interrupt enabled (PIE=1) and port interrupt flag not set (PIF=0).

4.6 Port H

This port is associated with the SPI1 and SPI2.

Port H pins PH[7:0] can be used for either general purpose I/O, or with the SPI subsystems.

During reset, port H pins are configured as high-impedance inputs.

Port H pins can be used with the routed SPI1 and SPI2 modules. Refer to **Figure 3-21**.

Port H offers 8 I/O ports with the same interrupt features as port P.

4.7 Port J

This port is associated with the CAN4, CAN0 and the IIC.

Port J pins PJ[7:6] and PJ[1:0] can be used for either general purpose I/O, or with the CAN and IIC subsystems.

During reset, port J pins are configured as inputs with pull-up.

If IIC takes precedence the pins become IIC open-drain output pins.

The CAN4 pins can be re-routed. Refer to **Figure 3-21**.

Port J pins can be used with the routed CAN0 modules. Refer to **Figure 3-21**.

Port J offers 4 I/O ports with the same interrupt features as port P.

4.8 Port A, B, E, K, and BKGD pin

All port and pin logic is located in the core module. *Refer to MEBI in HCS12 Core User Guide for details.*

4.9 External Pin Descriptions

All ports start up as general purpose inputs on reset.

4.10 Low Power Options

4.10.1 Run Mode

No low power options exist for this module in run mode.

4.10.2 Wait Mode

No low power options exist for this module in wait mode.

4.10.3 Stop Mode

All clocks are stopped. There are asynchronous paths to generate interrupts from STOP on port P, H and J.

Section 5 Initialization/Application Information

TBD

Index

-I-

Initialization/application information 49

Block Guide End Sheet

**FINAL PAGE OF
54
PAGES**