

HSMF-C15x

Bi-color Surface Mount Chip LEDs

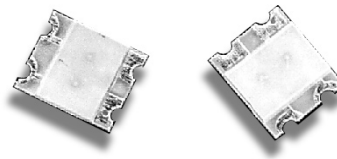

Data Sheet



HSMF-C153/C155/C156/C157/C158

Description

The HSMF-C15x series of bicolor chip-type LEDs is designed in an industry standard package for ease of handling and use. These bicolor LEDs are available as high efficiency red/yellow, high efficiency red/green, yellow/green, orange/green and green/amber. The HSMF-C15x has the widely used 3.2 x 2.7 mm footprint and wide viewing angle make this LED exceptional for backlighting applications.

All packages are compatible with reflow solder processes. The small size and wide viewing angle make these LEDs prime choices for backlighting applications and front panel indicators especially where space is a premium.

Features

- Small size
- Industry standard footprint
- Compatible with IR solder
- Diffused optics
- Operating temperature range of -30°C to $+85^{\circ}\text{C}$
- Five color combinations available:
Red/Yellow, Red/Green, Yellow/Green, Orange/Green and Green/Amber.
- Available in 8 mm tape on 7 in. (178 mm) diameter reels

Applications

- Push-button backlighting
- Symbol backlighting
- Status indicator
- Front panel indicator

Device Selection Guide

Part Number	Parts per Reel	Color	Package Description
HSMF-C153	3000	GaP HER / GaP Yellow	Untinted, Diffused
HSMF-C155	3000	GaP HER / GaP Green	Untinted, Diffused
HSMF-C156	3000	GaP Yellow / GaP Green	Untinted, Diffused
HSMF-C157	3000	GaP Orange / GaP Green	Untinted, Diffused
HSMF-C158	3000	AllnGaP Green / AllnGaP Amber	Untinted, Diffused

CAUTION: HSMF-C15x LEDs are Class 1A ESD sensitive per JESD22-A114C.01. Please observe appropriate precautions during handling and processing. Refer to Application Note AN-1142 for additional details.

Package Dimensions

HSMF-C153/C155/C156/C157/C158

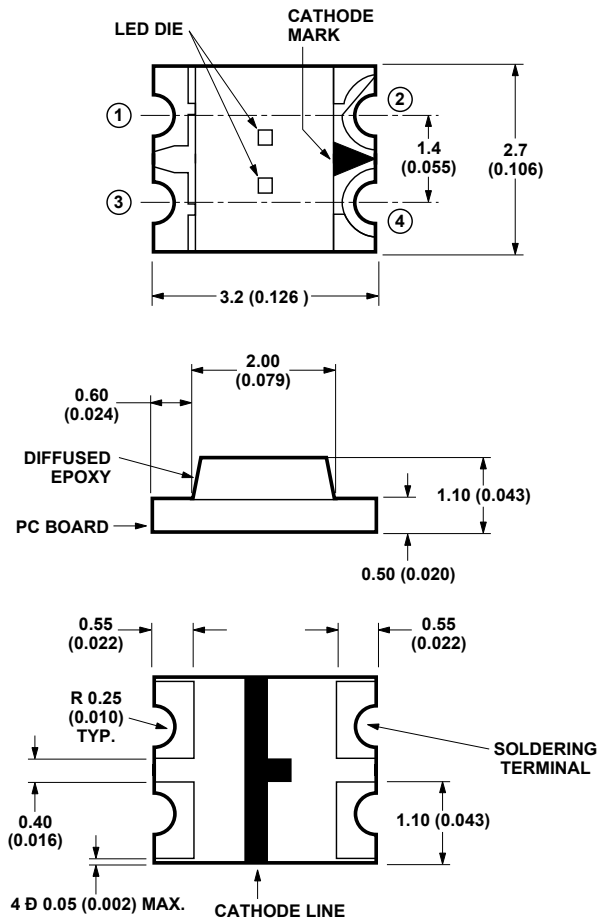

NOTES:

1. ALL DIMENSIONS IN MILLIMETERS (INCHES).
2. TOLERANCE IS ± 0.1 mm (± 0.004 IN.) UNLESS OTHERWISE SPECIFIED.

POLARITY	HSMF-C153	HSMF-C155	HSMF-C156	HSMF-C157	HSMF-C158
① — >— ②	HER	Green	Green	Green	Green
③ — >— ④	Yellow	HER	Yellow	Orange	Amber

Absolute Maximum Ratings at $T_A = 25^\circ\text{C}$

Parameter	GaP	AllnGaP Green	AllnGaP Amber	Units
DC Forward Current ^[1]	20	20	25	mA
Power Dissipation ^[2]	65	52	60	mW
Reverse Voltage ($I_R = 100\mu\text{A}$)	5	5	5	V
LED Junction Temperature	95	95	95	$^\circ\text{C}$
Operating Temperature Range	-30 to 85°C			
Storage Temperature Range	-40 to 85°C			
Soldering Temperature	See reflow soldering profile (Figure 6 & 7)			

Notes:

1. Derate linearly as shown in Figure 4 for temperature above 25°C .
2. Pulse condition of 1/10 duty and 0.1 msec. width.

Optical Characteristics at $T_A = 25^\circ\text{C}$

Part Number	Luminous Intensity I_v ^[1] (mcd) @ 20mA		Color, Peak Wavelength λ_d (nm) Typical	Color, Dominant Wavelength λ_d ^[2] (nm) Typical	Viewing Angle $2\theta_{1/2}$ ^[3] (Degrees) Typical
	Min.	Typ.			
GaP HER	2.50	10.0	630	626	170
GaP Yellow	2.50	8.0	589	586	170
GaP Green	4.00	15.0	570	572	170
GaP Orange	2.50	8.0	605	604	170
AllnGaP Green	28.50	45.0	570	572	170
AllnGaP Amber	28.50	55.0	595	592	170

Notes:

1. The luminous intensity I_v is measured at the peak of the spatial radiation pattern which may not be aligned with the mechanical axis of the LED package.
2. The dominant wavelength, λ_d , is derived from the CIE Chromaticity Diagram and represents the perceived color of the device.
3. $\lambda_{1/2}$ is the off-axis angle where the luminous intensity is $1/2$ the peak intensity.

Electrical Characteristics at $T_A = 25^\circ\text{C}$

Part Number	Forward Voltage V_F (Volts) ^[1] @ $I_F = 20\text{mA}$		Reverse Breakdown V_R (Volts) @ $I_R = 100\mu\text{A}$	Capacitance C (pF) @ $V_F = 0, f = 1\text{MHz}$	Thermal Resistance $R\theta_{J-P}$ ($^\circ\text{C}/\text{W}$)
	Typ.	Max.	Min.	Typ.	Typ.
GaP HER	2.1	2.6	5	5	325
GaP Yellow	2.1	2.6	5	6	325
GaP Green	2.2	2.6	5	9	325
GaP Orange	2.2	2.6	5	7	325
AllnGaP Green	2.1	2.4	5	22	325
AllnGaP Amber	1.9	2.4	5	45	325

Notes: The bicolor package contain two individual light sources of different color. The specifications above refer to each color of a particular package.

Color Bin Limits

GaP HER Color Bins ^[1]

Bin ID	Dominant Wavelength (nm)	
	Minimum	Maximum
-	620.0	630.0

Tolerance : ± 1 nm

GaP Yellow / AllnGaP Amber Color Bins ^[1]

Bin ID	Dominant Wavelength (nm)	
	Minimum	Maximum
A	582.0	584.5
B	584.5	587.0
C	587.0	589.5
D	589.5	592.0
E	592.0	594.5
F	594.5	597.0

Tolerance : ± 1 nm

GaP Orange Color Bins ^[1]

Bin ID	Dominant Wavelength (nm)	
	Minimum	Maximum
A	597.0	600.0
B	600.0	603.0
C	603.0	606.0
D	606.0	609.0
E	609.0	612.0
F	612.0	615.0

Tolerance : ± 1 nm

GaP Green Color Bins ^[1]

Bin ID	Dominant Wavelength (nm)	
	Minimum	Maximum
A	561.5	564.5
B	564.5	567.5
C	567.5	570.5
D	570.5	573.5
E	573.5	576.5

Tolerance : ± 1 nm

AllnGaP Green Color Bins ^[1]

Bin ID	Dominant Wavelength (nm)	
	Minimum	Maximum
A	561.5	564.5
B	564.5	567.5
C	567.5	570.5
D	570.5	573.5
E	573.5	576.5

Tolerance : ± 1 nm

Light Intensity (Iv) Bin Limits^[1]

Intensity (mcd)		
Bin ID	Min.	Max.
A	0.11	0.18
B	0.18	0.29
C	0.29	0.45
D	0.45	0.72
E	0.72	1.10
F	1.10	1.80
G	1.80	2.80
H	2.80	4.50
J	4.50	7.20
K	7.20	11.20
L	11.20	18.00
M	18.00	28.50

Intensity (mcd)		
Bin ID	Min.	Max.
N	28.50	45.00
P	45.00	71.50
Q	71.50	112.50
R	112.50	180.00
S	180.00	285.00
T	285.00	450.00
U	450.00	715.00
V	715.00	1125.00
W	1125.00	1800.00
X	1800.00	2850.00
Y	2850.00	4500.00

Tolerance: $\pm 15\%$.

Note:

- Bin categories are established for classification of products. Products may not be available in all categories. Please contact your Avago representative for information on currently available bins.

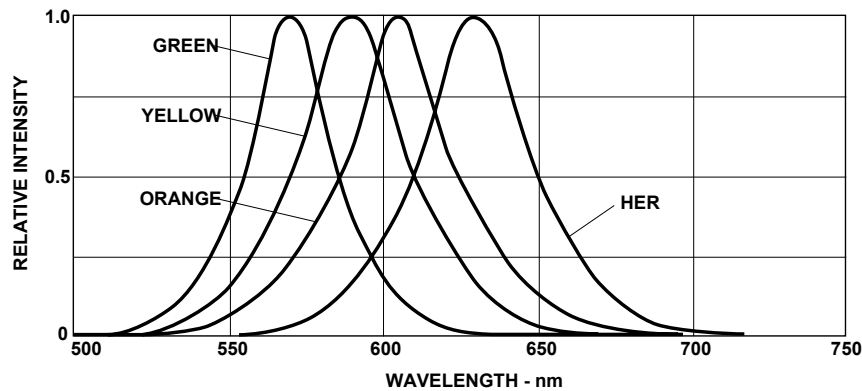

Figure 1. Relative intensity vs. wavelength.

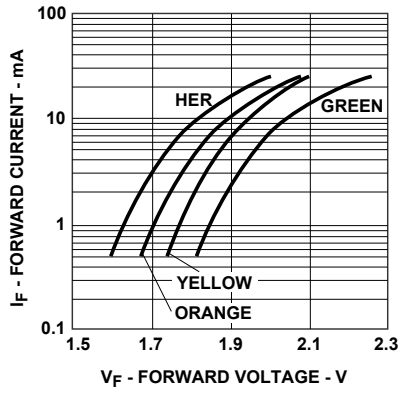

Figure 2. Forward current vs. forward voltage.

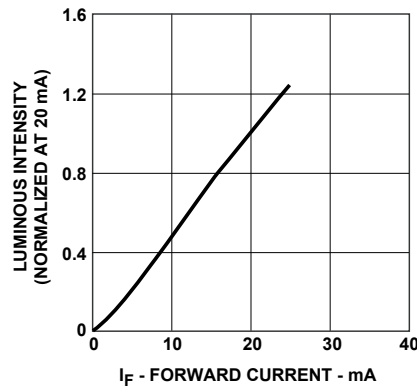

Figure 3. Luminous intensity vs. forward current (all colors).

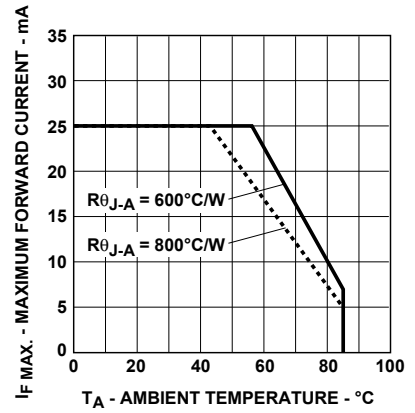

Figure 4. Maximum forward current vs. ambient temperature.

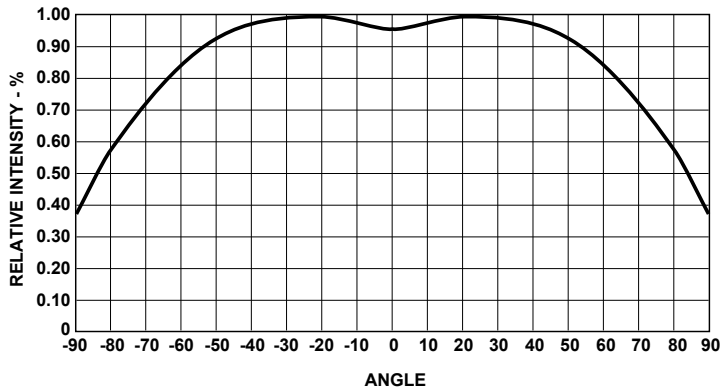

Figure 5. Relative intensity vs. angle for HSMF-C153, C155, C156, C157 and C158.

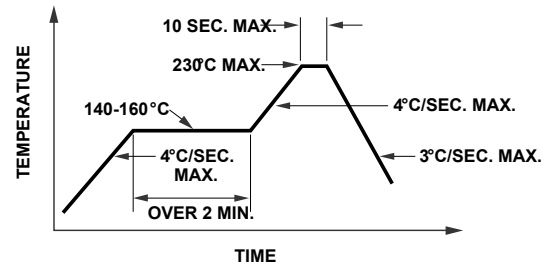

Figure 6. Recommended reflow soldering profile.

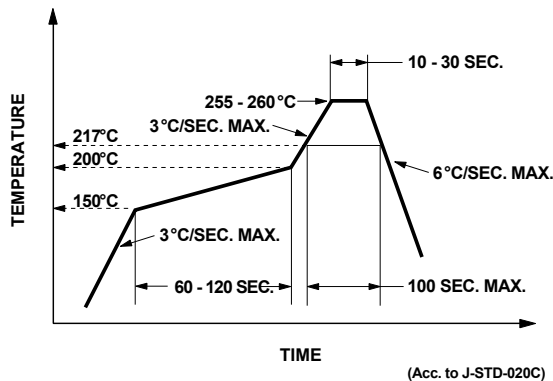
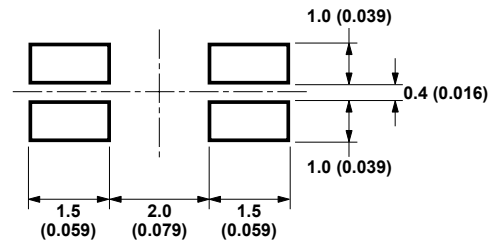

Figure 7. Recommended Pb free reflow soldering profile.



Note: 1. All dimensions in millimeters (inches).

Figure 8. Recommended solder pad pattern.

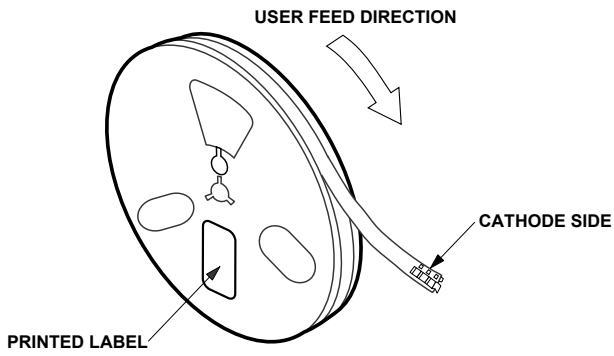
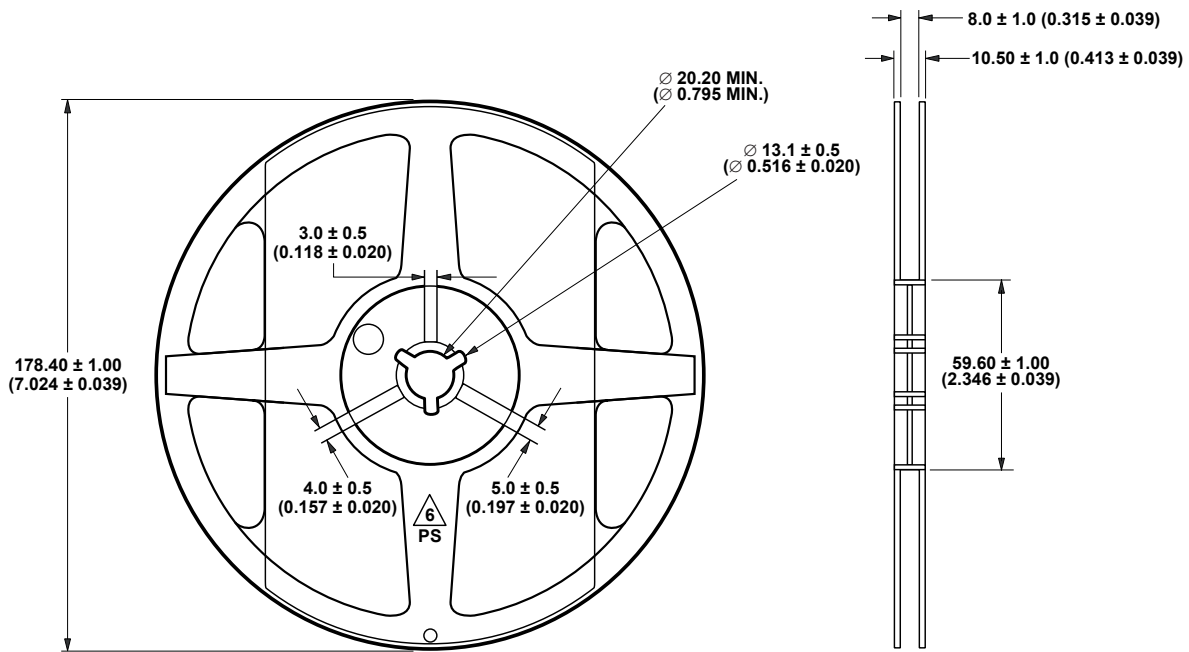

Figure 9. Reeling orientation.



Note:
All dimensions in millimeters (inches).

Figure 10. Reel dimensions.

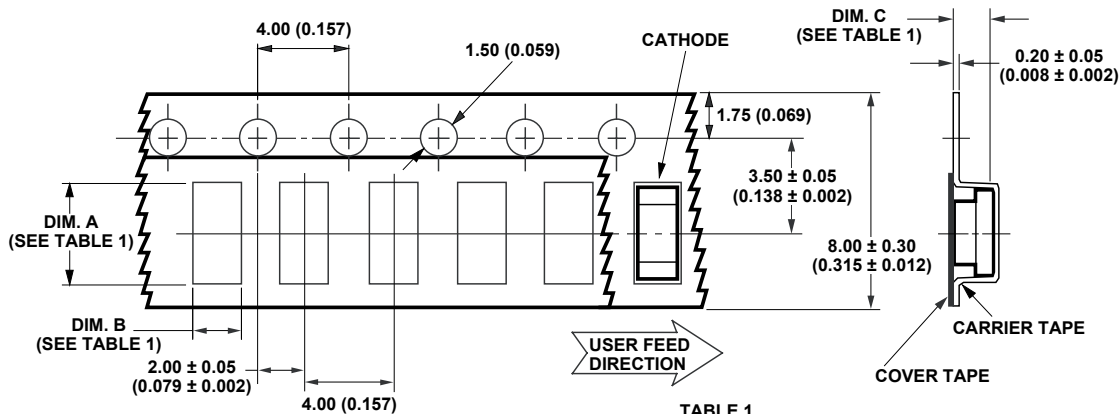

TABLE 1
DIMENSIONS IN MILLIMETERS (INCHES)

PART NUMBER	DIM. A ± 0.10 (0.004)	DIM. B ± 0.10 (0.004)	DIM. C ± 0.10 (0.004)
HSMF-C15x SERIES	3.52 (0.139)	3.02 (0.119)	1.40 (0.055)

Figure 11. Tape dimensions.

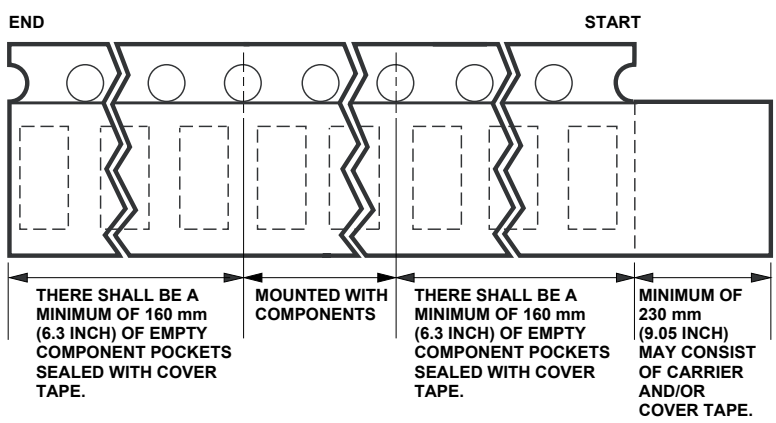

Figure 12. Tape leader and trailer dimensions.

Notes:

1. All dimensions in millimeters (inches).
2. Tolerance is ±0.1 mm (±0.004 in.) unless otherwise specified.

Convective IR Reflow Soldering

For more information on IR reflow soldering, refer to Application Note 1060, *Surface Mounting SMT LED Indicator Components*.

Storage Condition:

5 to 30°C @ 60% RH max.

Baking is required under the condition:

- a) Humidity Indicator Card is >10% when read at 23 ± 5°C
- b) Device exposed to factory conditions < 30°C/60% RH more than 672 hours.

Baking recommended condition: 60 ± 5°C for 20 hours.

For product information and a complete list of distributors, please go to our website: www.avagotech.com

