

MSD - 11207 MID-RANGE RF MODULE 1

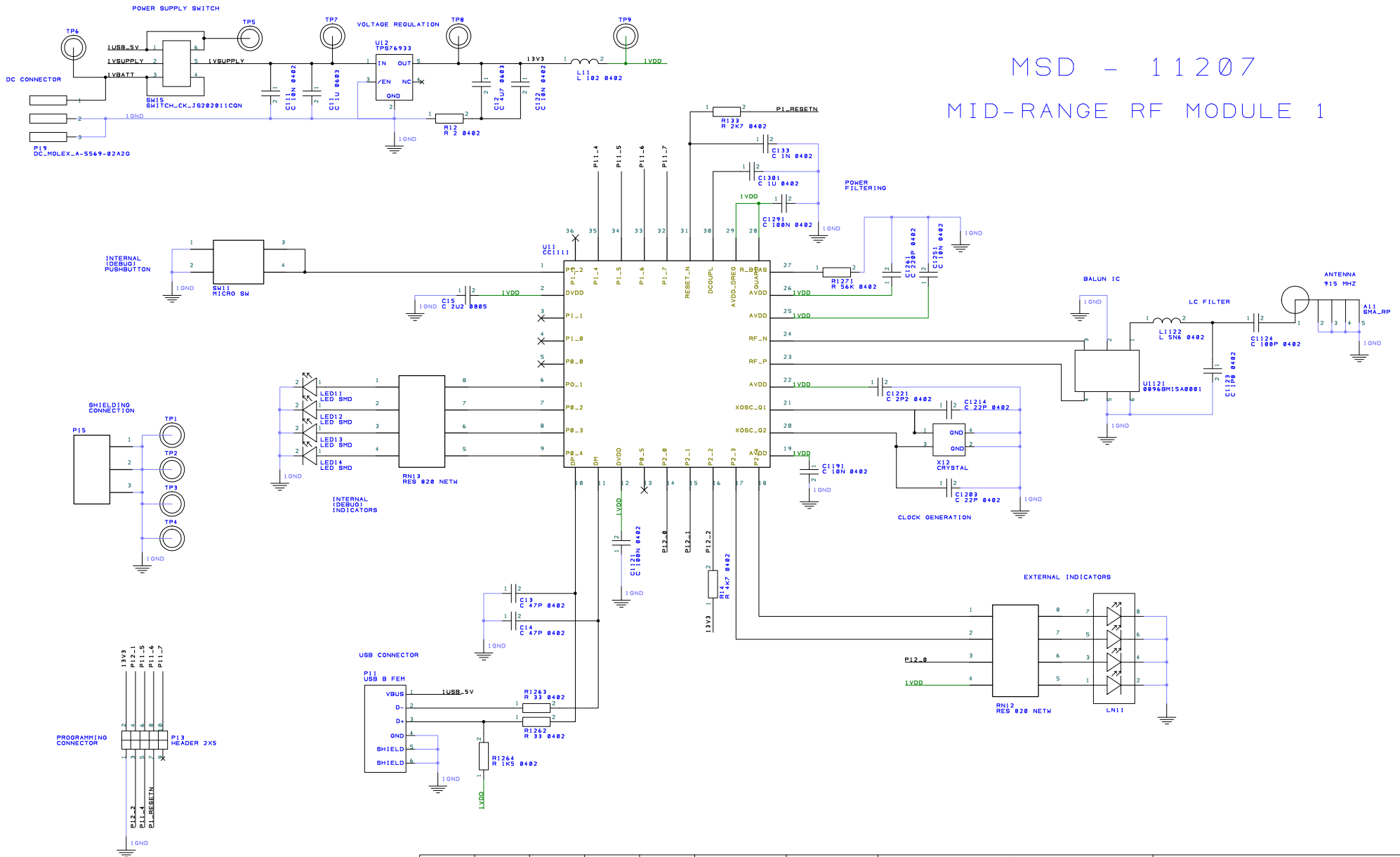

E	D	C	B	A	Drawn RMT	Check TDM	Projection Do Not Scale		
Drn	Drn	Drn	Drn	Project	MSD 11207		Client	HARRIS CORP	
Chk	Chk	Chk	Chk	Title	MID-RANGE RF MODULE		Filename	P11207.SCH	Drawing No. REV 5
									Sheet 1 of 1