

A1

(C) Texas Instruments
CC2530-CC2591EM 3.2

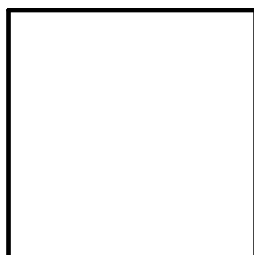

P3



X2

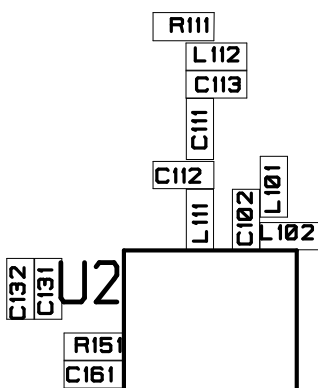

C2
L2

FM2

R11 R112
R14 R142

C321
C331

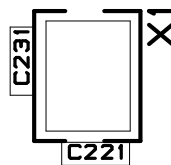
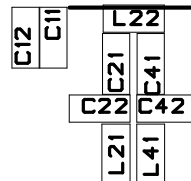

R301 C311 C211
C271 C272 C241

U1
C391

C1 L1

FM3

R04
R07 R072

P6

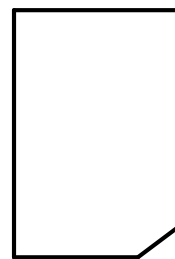

FM1

FMS

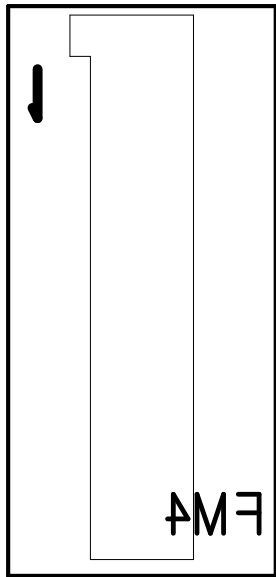

P1

FMS

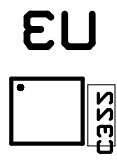

U3

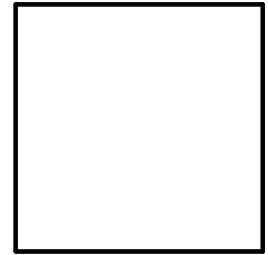

P4

P2

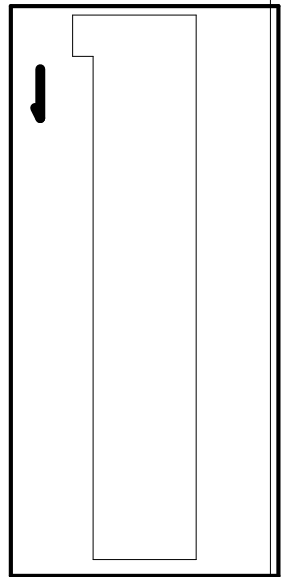

FMS

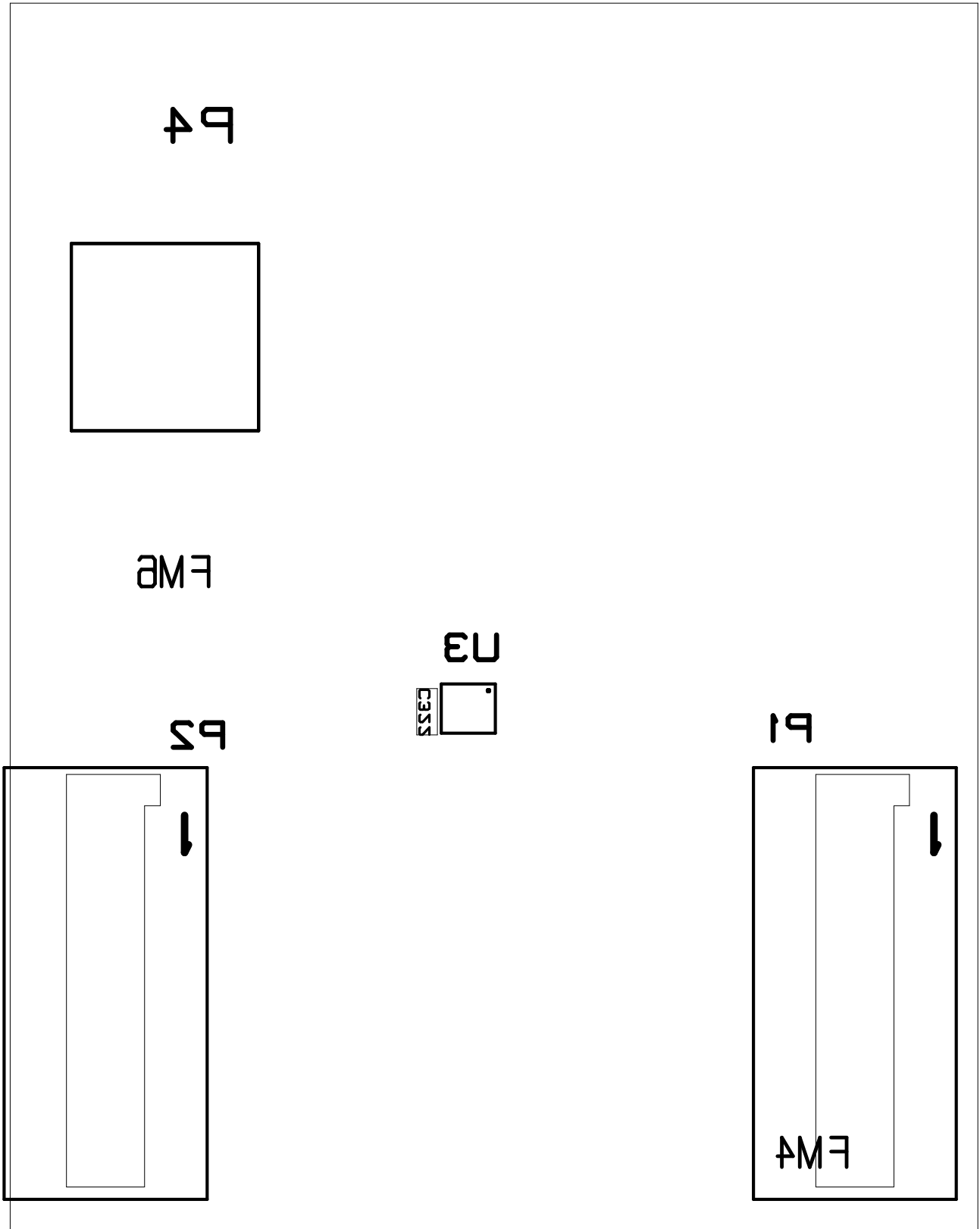

P4

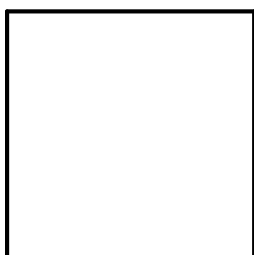

U3



P2

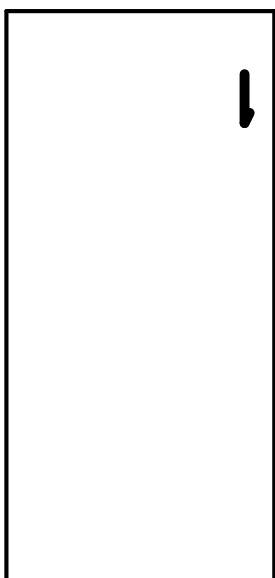

P1

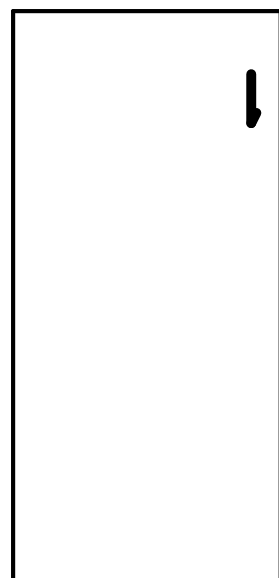

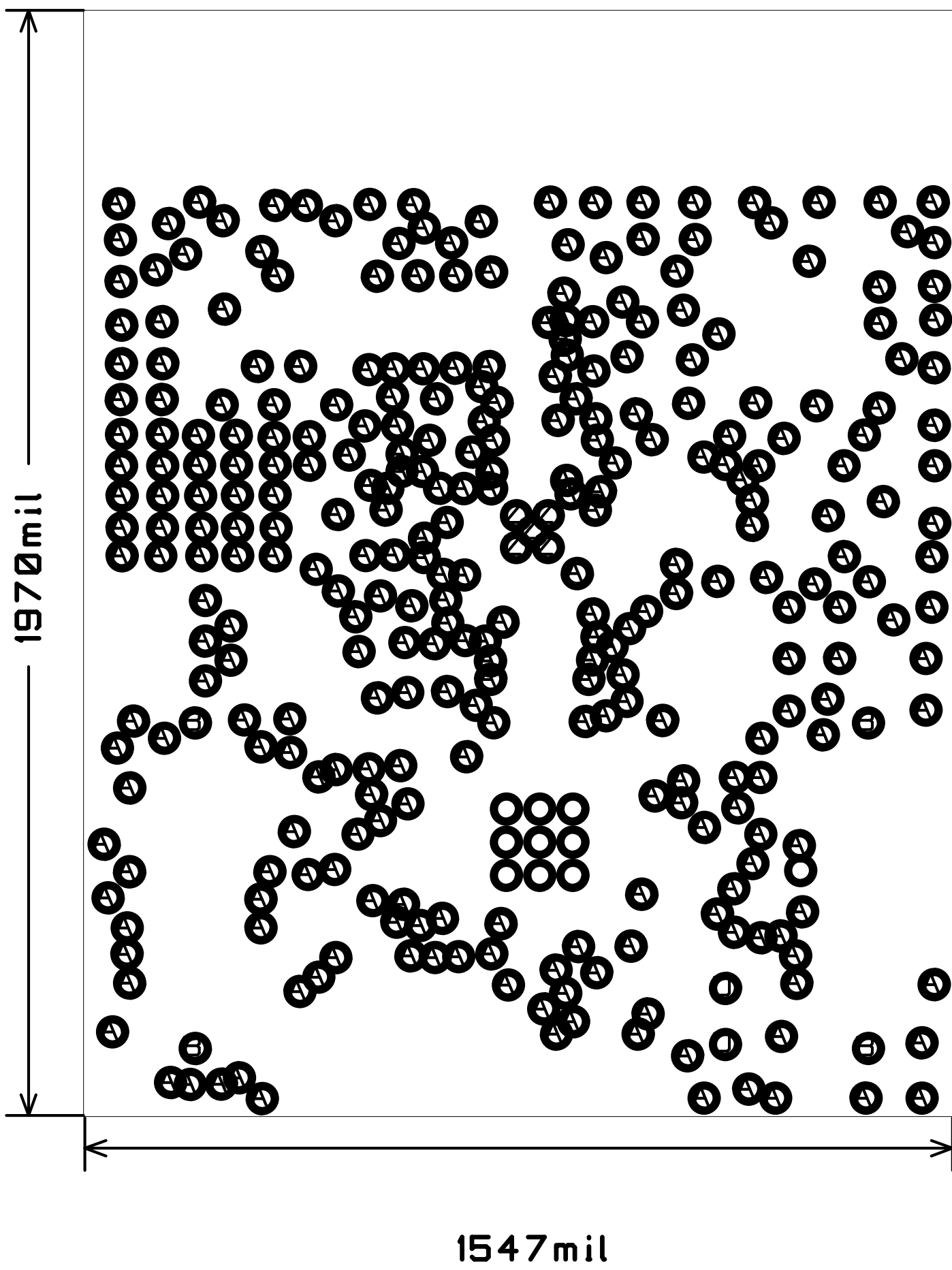

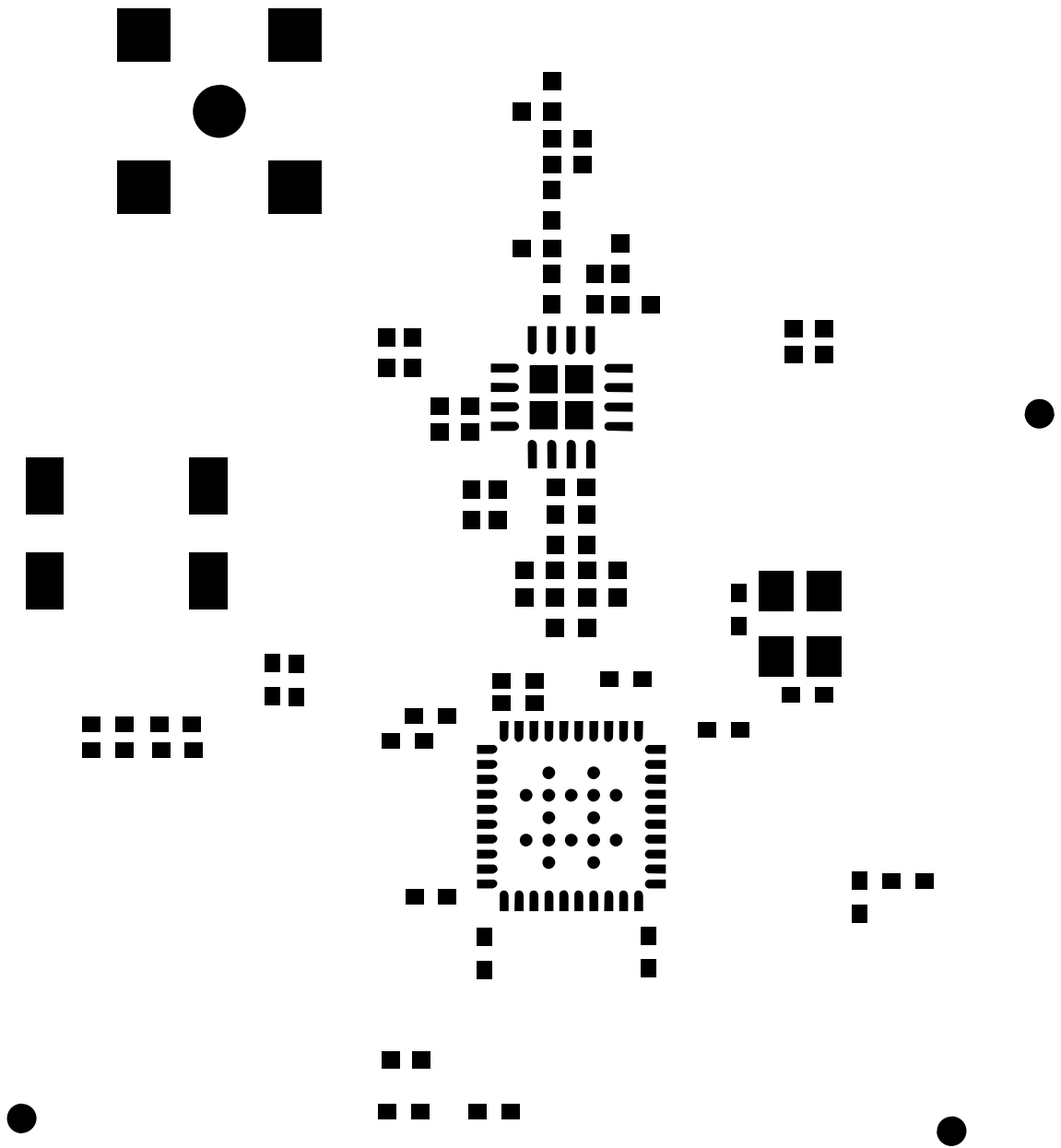

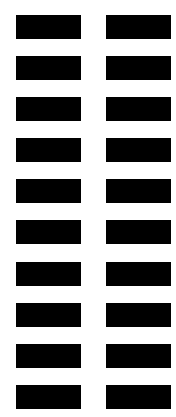
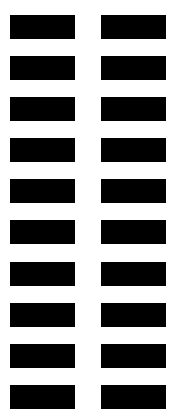
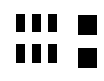
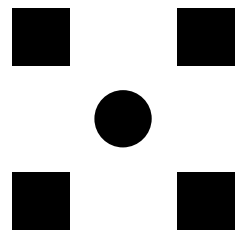

(C) Texas Instruments
CC2530-CC2591EM 3.2

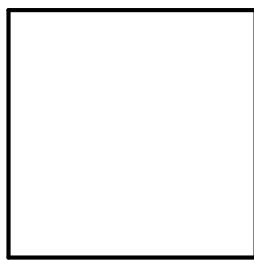

P3

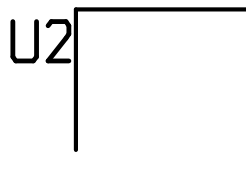

U2

FM2

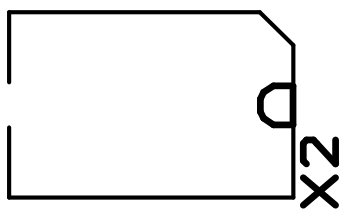

X2

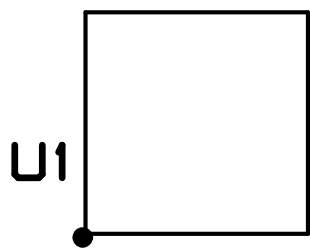
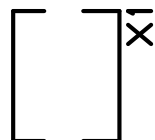

U1

FM3

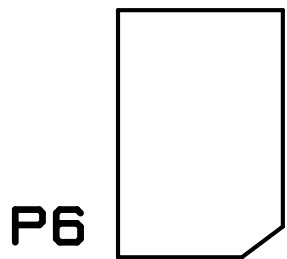

P6

FM1

P4

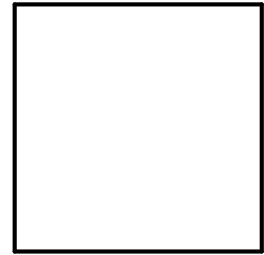

U3



P1

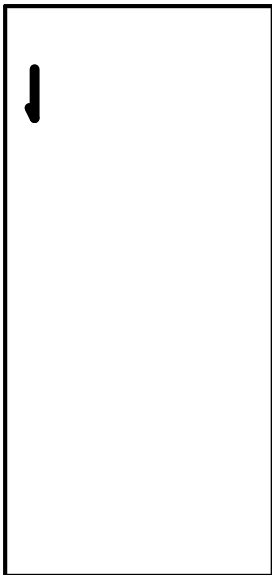

P2

