

A USB-Enabled System-On-Chip Solution for 2.4-GHz IEEE 802.15.4 and ZigBee Applications

Check for Samples: [CC2531F128](#), [CC2531F256](#)

FEATURES

- **RF/Layout**
 - 2.4-GHz IEEE 802.15.4 Compliant RF Transceiver
 - Excellent Receiver Sensitivity and Robustness to Interference
 - Programmable Output Power Up to 4.5 dBm
 - Few External Components
 - Only a Single Crystal Needed for Asynchronous Networks
 - 6-mm × 6-mm QFN40 Package
 - Suitable for Systems Targeting Compliance With Worldwide Radio-Frequency Regulations: ETSI EN 300 328 and EN 300 440 (Europe), FCC CFR47 Part 15 (US), and ARIB STD-T-66 (Japan)
- **USB**
 - USB 2.0 Certified Full Speed Device (12 Mbps)
 - 5 Highly Flexible Endpoints
 - 1-KB Dedicated FIFO
 - DMA Access to FIFO
 - No 48-MHz Crystal Required
- **Low Power**
 - Active Mode RX (CPU Idle): 24 mA
 - Active Mode TX at 1 dBm (CPU Idle): 29 mA
 - Power Mode 1 (4 μ s Wake-Up): 0.2 mA
 - Power Mode 2 (Sleep Timer Running): 1 μ A
 - Power Mode 3 (External Interrupts): 0.4 μ A
 - Wide Supply-Voltage Range (2 V–3.6 V)
- **Microcontroller**
 - High-Performance and Low-Power 8051 Microcontroller Core With Code Prefetch
 - 256-KB or 128-KB In-System-Programmable Flash
 - 8-KB RAM With Retention in All Power Modes
 - Hardware Debug Support
- **Peripherals**
 - Powerful Five-Channel DMA
 - IEEE 802.15.4 MAC Timer, General-Purpose Timers (One 16-Bit, Two 8-Bit)
 - IR Generation Circuitry
 - 32-kHz Sleep Timer With Capture
 - CSMA/CA Hardware Support
 - Accurate Digital RSSI/LQI Support
 - Battery Monitor and Temperature Sensor
 - 12-Bit ADC With Eight Channels and Configurable Resolution
 - AES Security Coprocessor
 - Two Powerful USARTs With Support for Several Serial Protocols
 - 21 General-Purpose I/O Pins (19 × 4 mA, 2 × 20 mA)
 - Watchdog Timer
- **Development Tools**
 - CC2531 Development Kit
 - Certified CC2531 USB Dongle Reference Design
 - SmartRF™ Software
 - Packet Sniffer
 - IAR Embedded Workbench® Software Available



Please be aware that an important notice concerning availability, standard warranty, and use in critical applications of Texas Instruments semiconductor products and disclaimers thereto appears at the end of this data sheet.

SmartRF, Z-Stack, RemoTI are trademarks of Texas Instruments.
IAR Embedded Workbench is a registered trademark of IAR Systems AB.
ZigBee is a registered trademark of ZigBee Alliance.
All other trademarks are the property of their respective owners.

APPLICATIONS

- **USB Upgradable 2.4-GHz IEEE 802.15.4 Systems**
- **RF4CE Remote Control Target for TV or STB**
- **PC Peripherals**
- **ZigBee® Systems**
- **Home/Building Automation**
- **Lighting Systems**
- **Industrial Control and Monitoring**
- **Low-Power Wireless Sensor Networks**
- **Consumer Electronics**
- **Health Care**



This integrated circuit can be damaged by ESD. Texas Instruments recommends that all integrated circuits be handled with appropriate precautions. Failure to observe proper handling and installation procedures can cause damage.

ESD damage can range from subtle performance degradation to complete device failure. Precision integrated circuits may be more susceptible to damage because very small parametric changes could cause the device not to meet its published specifications.

DESCRIPTION

The CC2531 is a USB enabled true system-on-chip (SoC) solution for IEEE 802.15.4, ZigBee and RF4CE applications. It enables USB dongles or USB upgradable network nodes to be built with low total bill-of-material costs. The CC2531 combines the performance of a leading RF transceiver with an industry-standard enhanced 8051 MCU, in-system programmable flash memory, 8-KB RAM, and many other powerful features. The CC2531 has various operating modes, making it suited for systems where ultralow power consumption is required. Short transition times between operating modes further ensure low energy consumption. Source code for USB HID and CDC libraries and examples are downloadable from the CC2531 product page on www.ti.com.

Combined with the industry-leading and golden-unit-status ZigBee protocol stack (Z-Stack™) from Texas Instruments, the CC2531 provides a robust and complete ZigBee USB dongle or firmware upgradable network node.

Combined with the golden-unit-status RemoTI™ stack from Texas Instruments, the CC2531 provides a robust ZigBee RF4CE remote-control target for USB dongle or TV/STB implementations.

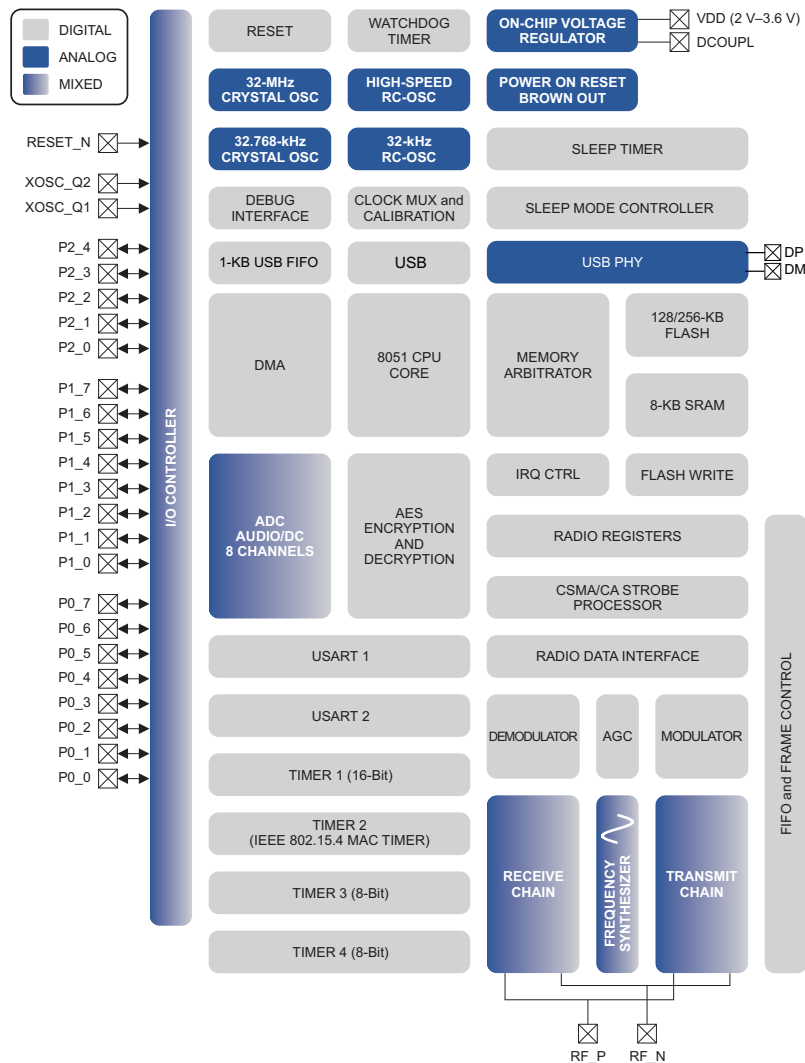

80300-02

ABSOLUTE MAXIMUM RATINGS⁽¹⁾

		MIN	MAX	UNIT
Supply voltage	All supply pins must have the same voltage	-0.3	3.9	V
Voltage on any digital pin		-0.3	$V_{DD} + 0.3, \leq 3.9$	V
Input RF level			10	dBm
Storage temperature range		-40	125	°C
ESD ⁽²⁾	All pads, according to human-body model, JEDEC STD 22, method A114		2	kV
	According to charged-device model, JEDEC STD 22, method C101		500	V

- (1) Stresses beyond those listed under *Absolute Maximum Ratings* may cause permanent damage to the device. These are stress ratings only, and functional operation of the device at these or any other conditions beyond those indicated under *Recommended Operating Conditions* is not implied. Exposure to absolute-maximum-rated conditions for extended periods may affect device reliability.
- (2) CAUTION: ESD-sensitive device. Precautions should be used when handling the device in order to prevent permanent damage.

RECOMMENDED OPERATING CONDITIONS

	MIN	MAX	UNIT
Operating ambient temperature range, T _A	-40	125	°C
Operating supply voltage	2	3.6	V

ELECTRICAL CHARACTERISTICS

Measured on Texas Instruments CC2530 EM reference design with T_A = 25°C and V_{DD} = 3 V, unless otherwise noted. **Boldface** limits apply over the entire operating range, T_A = -40°C to 125°C, V_{DD} = 2 V to 3.6 V, and f_c = 2394 MHz to 2507 MHz.

PARAMETER		TEST CONDITIONS	MIN	TYP	MAX	UNIT
I _{core}	Core current consumption	Digital regulator on. 16-MHz RCOSC running. No radio, crystals, or peripherals active. Medium CPU activity: normal flash access ⁽¹⁾ , no RAM access		3.4		mA
		32-MHz XOSC running. No radio or peripherals active. Medium CPU activity: normal flash access ⁽¹⁾ , no RAM access		6.5	8.9	mA
		32-MHz XOSC running, radio in RX mode, -50-dBm input power, no peripherals active, CPU idle		20.5		mA
		32-MHz XOSC running, radio in RX mode at -100-dBm input power (waiting for signal), no peripherals active, CPU idle		24.3	29.6	mA
		32-MHz XOSC running, radio in TX mode, 1-dBm output power, no peripherals active, CPU idle		28.7		mA
		32-MHz XOSC running, radio in TX mode, 4.5-dBm output power, no peripherals active, CPU idle		33.5	39.6	mA
		Power mode 1. Digital regulator on; 16-MHz RCOSC and 32-MHz crystal oscillator off; 32.768-kHz XOSC, POR, BOD and sleep timer active; RAM and register retention		0.2	0.3	mA
		Power mode 2. Digital regulator off; 16-MHz RCOSC and 32-MHz crystal oscillator off; 32.768-kHz XOSC, POR, and sleep timer active; RAM and register retention		1	2	μA
		Power mode 3. Digital regulator off; no clocks; POR active; RAM and register retention		0.4	1	μA
I _{peri}	Peripheral Current Consumption (Adds to core current I _{core} for each peripheral unit activated)					
	Timer 1	Timer running, 32-MHz XOSC used		90		μA
	Timer 2	Timer running, 32-MHz XOSC used		90		μA
	Timer 3	Timer running, 32-MHz XOSC used		60		μA
	Timer 4	Timer running, 32-MHz XOSC used		70		μA
	Sleep timer	Including 32.753-kHz RCOSC		0.6		μA
	USB	Measured on CC2531 dongle reference design, 48-MHz clock running, USB enabled		0.1		mA
	ADC	When converting		1.2		mA
	Flash	Erase		1		mA
		Burst write peak current		6		mA

(1) Normal flash access means that the code used exceeds the cache storage, so cache misses happen frequently.

GENERAL CHARACTERISTICS

Measured on Texas Instruments CC2530 EM reference design with T_A = 25°C and V_{DD} = 3 V, unless otherwise noted.

PARAMETER	TEST CONDITIONS	MIN	TYP	MAX	UNIT
WAKE-UP AND TIMING					
Power mode 1 → active	Digital regulator on, 16-MHz RCOSC and 32-MHz crystal oscillator off. Start-up of 16-MHz RCOSC		4		μs
Power mode 2 or 3 → active	Digital regulator off, 16-MHz RCOSC and 32-MHz crystal oscillator off. Start-up of regulator and 16-MHz RCOSC		0.1		ms
Active → TX or RX	Initially running on 16-MHz RCOSC, with 32-MHz XOSC off		0.5		ms
	With 32-MHz XOSC initially on			192	μs

GENERAL CHARACTERISTICS (continued)

 Measured on Texas Instruments CC2530 EM reference design with $T_A = 25^\circ\text{C}$ and $V_{DD} = 3\text{ V}$, unless otherwise noted.

PARAMETER	TEST CONDITIONS	MIN	TYP	MAX	UNIT
RX/TX and TX/RX turnaround				192	μs
USB PLL start-up time	With 32-MHz XOSC initially on		32		μs
RADIO PART					
RF frequency range	Programmable in 1-MHz steps, 5 MHz between channels for compliance with [1]	2394		2507	MHz
Radio baud rate	As defined by [1]		250		kbps
Radio chip rate	As defined by [1]		2		MChip/s
Flash erase cycles				20	k Cycles
Flash page size			2		KB

RF RECEIVE SECTION

Measured on Texas Instruments CC2530 EM reference design with $T_A = 25^\circ\text{C}$, $V_{DD} = 3\text{ V}$, and $f_c = 2440\text{ MHz}$, unless otherwise noted.

Bold limits apply over the entire operating range, $T_A = -40^\circ\text{C}$ to 125°C , $V_{DD} = 2\text{ V}$ to 3.6 V , and $f_c = 2394\text{ MHz}$ to 2507 MHz .

PARAMETER	TEST CONDITIONS	MIN	TYP	MAX	UNIT
Receiver sensitivity	PER = 1%, as specified by [1] [1] requires -85 dBm		-97	-92	dBm
				-88	
Saturation (maximum input level)	PER = 1%, as specified by [1] [1] requires -20 dBm		10		dBm
Adjacent-channel rejection, 5-MHz channel spacing	Wanted signal -82 dBm, adjacent modulated channel at 5 MHz, PER = 1%, as specified by [1]. [1] requires 0 dB		49		dB
Adjacent-channel rejection, -5-MHz channel spacing	Wanted signal -82 dBm, adjacent modulated channel at -5 MHz, PER = 1%, as specified by [1]. [1] requires 0 dB		49		dB
Alternate-channel rejection, 10-MHz channel spacing	Wanted signal -82 dBm, adjacent modulated channel at 10 MHz, PER = 1%, as specified by [1] [1] requires 30 dB		57		dB
Alternate-channel rejection, -10-MHz channel spacing	Wanted signal -82 dBm, adjacent modulated channel at -10 MHz, PER = 1%, as specified by [1] [1] requires 30 dB		57		dB
Channel rejection ≥ 20 MHz ≤ -20 MHz	Wanted signal at -82 dBm. Undesired signal is an IEEE 802.15.4 modulated channel, stepped through all channels from 2405 to 2480 MHz. Signal level for PER = 1%.		57	57	dB
Co-channel rejection	Wanted signal at -82 dBm. Undesired signal is 802.15.4 modulated at the same frequency as the desired signal. Signal level for PER = 1%.		-3		dB
Blocking/desensitization 5 MHz from band edge 10 MHz from band edge 20 MHz from band edge 50 MHz from band edge -5 MHz from band edge -10 MHz from band edge -20 MHz from band edge -50 MHz from band edge	Wanted signal 3 dB above the sensitivity level, CW jammer, PER = 1%. Measured according to EN 300 440 class 2.		-33	-33	dBm
			-32		
			-31		
			-35		
			-35		
			-34		
			-34		
			-34		
Spurious emission. Only largest spurious emission stated within each band. 30 MHz–1000 MHz 1 GHz–12.75 GHz	Conducted measurement with a 50-Ω single-ended load. Suitable for systems targeting compliance with EN 300 328, EN 300 440, FCC CFR47 Part 15, and ARIB STD-T-66.		≤80	-57	dBm
Frequency error tolerance ⁽¹⁾	[1] requires minimum 80 ppm		±150		ppm
Symbol rate error tolerance ⁽²⁾	[1] requires minimum 80 ppm		±1000		ppm
Sensitivity impact of USB operation	Measured on CC2531 dongle reference design with CDC bulk transfer to PC at maximum speed		0.5		dB

(1) Difference between center frequency of the received RF signal and local oscillator frequency

(2) Difference between incoming symbol rate and the internally generated symbol rate

RF TRANSMIT SECTION

Measured on Texas Instruments CC2530 EM reference design with $T_A = 25^\circ\text{C}$, $V_{DD} = 3\text{ V}$ and $f_c = 2440\text{ MHz}$, unless otherwise noted.

Boldface limits apply over the entire operating range, $T_A = -40^\circ\text{C}$ to 125°C , $V_{DD} = 2\text{ V}$ to 3.6 V , and $f_c = 2394\text{ MHz}$ to 2507 MHz .

PARAMETER	TEST CONDITIONS	MIN	TYP	MAX	UNIT
Nominal output power	Delivered to a single-ended 50-Ω load through a balun using maximum-recommended output-power setting [1] requires minimum -3 dBm	0	4.5	8	dBm
		-8		10	
Programmable output power range			32		dB
Spurious emissions	Max recommended output power setting ⁽¹⁾ Measured according to stated regulations.				dBm
Only largest spurious emission stated within each band.	25 MHz–1000 MHz (outside restricted bands)		-60		
	25 MHz–2400 MHz (within FCC restricted bands)		-60		
	25 MHz–1000 MHz (within ETSI restricted bands)		-60		
	1800–1900 MHz (ETSI restricted band)		-57		
	5150–5300 MHz (ETSI restricted band)		-55		
	At $2 \times f_c$ and $3 \times f_c$ (FCC restricted band)		-42		
	At $2 \times f_c$ and $3 \times f_c$ (ETSI EN 300-440 and EN 300-328) ⁽²⁾		-31		
1 GHz–12.75 GHz (outside restricted bands)		-53			
	At 2483.5 MHz and above (FCC restricted band) $f_c = 2480\text{ MHz}$ ⁽³⁾		-42		
Error vector magnitude (EVM)	Measured as defined by [1] using maximum-recommended output-power setting [1] requires maximum 35%.		2%		
Optimum load impedance	Differential impedance as seen from the RF port (RF_P and RF_N) towards the antenna		69 + j29		Ω

(1) Texas Instruments CC2530 EM reference design is suitable for systems targeting compliance with EN 300 328, EN 300 440, FCC CFR47 Part 15, and ARIB STD-T-66.

(2) Margins for passing conducted requirements at the third harmonic can be improved by using a simple band-pass filter connected between matching network and RF connector (1.8 pF in parallel with 1.6 nH); this filter must be connected to a good RF ground.

(3) Margins for passing FCC requirements at 2483.5 MHz and above when transmitting at 2480 MHz can be improved by using a lower output-power setting or having less than 100% duty cycle.

32-MHz CRYSTAL OSCILLATOR

Measured on Texas Instruments CC2530 EM reference design with $T_A = 25^\circ\text{C}$ and $V_{DD} = 3\text{ V}$, unless otherwise noted.

PARAMETER	TEST CONDITIONS	MIN	TYP	MAX	UNIT
Crystal frequency			32		MHz
Crystal frequency accuracy requirement ⁽¹⁾		-40		40	ppm
ESR Equivalent series resistance		6		60	Ω
C_0 Crystal shunt capacitance		1		7	pF
C_L Crystal load capacitance		10		16	pF
Start-up time			0.3		ms
Power-down guard time	The crystal oscillator must be in power down for a guard time before it is used again. This requirement is valid for all modes of operation. The need for power-down guard time can vary with crystal type and load.	3			ms

(1) Including aging and temperature dependency, as specified by [1]

32.768-kHz CRYSTAL OSCILLATOR

Measured on Texas Instruments CC2530 EM reference design with $T_A = 25^\circ\text{C}$ and $V_{DD} = 3\text{ V}$, unless otherwise noted.

PARAMETER	TEST CONDITIONS	MIN	TYP	MAX	UNIT
Crystal frequency			32.768		kHz
Crystal frequency accuracy requirement ⁽¹⁾		-40		40	ppm
ESR Equivalent series resistance			40	130	k Ω
C_0 Crystal shunt capacitance			0.9	2	pF
C_L Crystal load capacitance			12	16	pF
Start-up time			0.4		s

(1) Including aging and temperature dependency, as specified by [1]

32-kHz RC OSCILLATOR

Measured on Texas Instruments CC2530 EM reference design with $T_A = 25^\circ\text{C}$ and $V_{DD} = 3\text{ V}$, unless otherwise noted.

PARAMETER	TEST CONDITIONS	MIN	TYP	MAX	UNIT
Calibrated frequency ⁽¹⁾			32.753		kHz
Frequency accuracy after calibration			$\pm 0.2\%$		
Temperature coefficient ⁽²⁾			0.4		%/ $^\circ\text{C}$
Supply-voltage coefficient ⁽³⁾			3		%/V
Calibration time ⁽⁴⁾			2		ms

(1) The calibrated 32-kHz RC oscillator frequency is the 32-MHz XTAL frequency divided by 977.

(2) Frequency drift when temperature changes after calibration

(3) Frequency drift when supply voltage changes after calibration

(4) When the 32-kHz RC oscillator is enabled, it is calibrated when a switch from the 16-MHz RC oscillator to the 32-MHz crystal oscillator is performed while SLEPCMD.OSC32K_CALDIS is 0.

16-MHz RC OSCILLATOR

Measured on Texas Instruments CC2530 EM reference design with $T_A = 25^\circ\text{C}$ and $V_{DD} = 3\text{ V}$, unless otherwise noted.

PARAMETER	TEST CONDITIONS	MIN	TYP	MAX	UNIT
Frequency ⁽¹⁾			16		MHz
Uncalibrated frequency accuracy			±18%		
Calibrated frequency accuracy			±0.6%	±1%	
Start-up time				10	μs
Initial calibration time ⁽²⁾			50		μs

(1) The calibrated 16-MHz RC oscillator frequency is the 32-MHz XTAL frequency divided by 2.

(2) When the 16-MHz RC oscillator is enabled, it is calibrated when a switch from the 16-MHz RC oscillator to the 32-MHz crystal oscillator is performed while SLEEP_CMD.OSC_PD is set to 0.

RSSI/CCA CHARACTERISTICS

Measured on Texas Instruments CC2530 EM reference design with $T_A = 25^\circ\text{C}$ and $V_{DD} = 3\text{ V}$, unless otherwise noted.

PARAMETER	TEST CONDITIONS	MIN	TYP	MAX	UNIT
RSSI range			100		dB
Absolute uncalibrated RSSI/CCA accuracy			±4		dB
RSSI/CCA offset ⁽¹⁾			73		dB
Step size (LSB value)			1		dB

(1) Real RSSI = Register value – offset

FREQEST CHARACTERISTICS

Measured on Texas Instruments CC2530 EM reference design with $T_A = 25^\circ\text{C}$ and $V_{DD} = 3\text{ V}$, unless otherwise noted.

PARAMETER	TEST CONDITIONS	MIN	TYP	MAX	UNIT
FREQEST range			±250		kHz
FREQEST accuracy			±40		kHz
FREQEST offset ⁽¹⁾			20		kHz
Step size (LSB value)			7.8		kHz

(1) Real FREQEST = Register value – offset

FREQUENCY SYNTHESIZER CHARACTERISTICS

Measured on Texas Instruments CC2530 EM reference design with $T_A = 25^\circ\text{C}$, $V_{DD} = 3\text{ V}$ and $f_c = 2440\text{ MHz}$, unless otherwise noted.

PARAMETER	TEST CONDITIONS	MIN	TYP	MAX	UNIT
Phase noise, unmodulated carrier	At ±1-MHz offset from carrier		-110		dBc/Hz
	At ±2-MHz offset from carrier		-117		
	At ±5-MHz offset from carrier		-122		

ANALOG TEMPERATURE SENSOR

Measured on Texas Instruments CC2530 EM reference design with $T_A = 25^\circ\text{C}$ and $V_{DD} = 3\text{ V}$, unless otherwise noted.

PARAMETER	TEST CONDITIONS	MIN	TYP	MAX	UNIT
Output at 25°C	Measured using integrated ADC, using internal bandgap voltage reference and maximum resolution		1480		12-bit ADC
Temperature coefficient			4.5		/1°C
Voltage coefficient			1		/0.1 V
Initial accuracy without calibration			±10		°C
Accuracy using 1-point calibration (entire temperature range)			±5		°C
Current consumption when enabled (ADC current not included)				0.5	

ADC CHARACTERISTICS

$T_A = 25^\circ\text{C}$ and $V_{DD} = 3\text{ V}$, unless otherwise noted.

PARAMETER		TEST CONDITIONS	MIN	TYP	MAX	UNIT
	Input voltage	V_{DD} is voltage on AVDD5 pin	0	V_{DD}		V
	External reference voltage	V_{DD} is voltage on AVDD5 pin	0	V_{DD}		V
	External reference voltage differential	V_{DD} is voltage on AVDD5 pin	0	V_{DD}		V
	Input resistance, signal	Using 4-MHz clock speed		197		k Ω
	Full-scale signal ⁽¹⁾	Peak-to-peak, defines 0 dBFS		2.97		V
ENOB ⁽¹⁾	Effective number of bits	Single-ended input, 7-bit setting		5.7		bits
		Single-ended input, 9-bit setting		7.5		
		Single-ended input, 10-bit setting		9.3		
		Single-ended input, 12-bit setting		10.8		
		Differential input, 7-bit setting		6.5		
		Differential input, 9-bit setting		8.3		
		Differential input, 10-bit setting		10.0		
	Useful power bandwidth	7-bit setting, both single and differential		0–20		kHz
THD ⁽¹⁾	Total harmonic distortion	Single-ended input, 12-bit setting, –6 dBFS		–75.2		dB
		Differential input, 12-bit setting, –6 dBFS		–86.6		
	Signal to nonharmonic ratio ⁽¹⁾	Single-ended input, 12-bit setting		70.2		dB
		Differential input, 12-bit setting		79.3		
		Single-ended input, 12-bit setting, –6 dBFS		78.8		
		Differential input, 12-bit setting, –6 dBFS		88.9		
CMRR	Common-mode rejection ratio	Differential input, 12-bit setting, 1-kHz sine (0 dBFS), limited by ADC resolution		>84		dB
	Crosstalk	Single-ended input, 12-bit setting, 1-kHz sine (0 dBFS), limited by ADC resolution		>84		dB
	Offset	Midscale		–3		mV
	Gain error			0.68%		
DNL ⁽¹⁾	Differential nonlinearity	12-bit setting, mean		0.05		LSB
		12-bit setting, maximum		0.9		
INL ⁽¹⁾	Integral nonlinearity	12-bit setting, mean		4.6		LSB
		12-bit setting, maximum		13.3		
SINAD ⁽¹⁾ (–THD+N)	Signal-to-noise-and-distortion	Single-ended input, 7-bit setting		35.4		dB
		Single-ended input, 9-bit setting		46.8		
		Single-ended input, 10-bit setting		57.5		
		Single-ended input, 12-bit setting		66.6		
		Differential input, 7-bit setting		40.7		
		Differential input, 9-bit setting		51.6		
		Differential input, 10-bit setting		61.8		
	Conversion time	7-bit setting		20		μs
		9-bit setting		36		
		10-bit setting		68		
		12-bit setting		132		
	Power consumption			1.2		mA
	Internal reference voltage			1.15		V
	Internal reference VDD coefficient			4		mV/V
	Internal reference temperature coefficient			0.4		mV/10 $^\circ\text{C}$

(1) Measured with 300-Hz sine-wave input and VDD as reference.

CONTROL INPUT AC CHARACTERISTICS

$T_A = -40^{\circ}\text{C}$ to 125°C , $V_{DD} = 2\text{ V}$ to 3.6 V , unless otherwise noted.

PARAMETER	TEST CONDITIONS	MIN	TYP	MAX	UNIT
System clock, f_{SYSCLK} $t_{\text{SYSCLK}} = 1/f_{\text{SYSCLK}}$	The undivided system clock is 32 MHz when crystal oscillator is used. The undivided system clock is 16 MHz when calibrated 16-MHz RC oscillator is used.	16		32	MHz
RESET_N low duration	See item 1, Figure 1. This is the shortest pulse that is recognized as a complete reset pin request. Note that shorter pulses may be recognized but might not lead to complete reset of all modules within the chip.	1			μs
Interrupt pulse duration	See item 2, Figure 1. This is the shortest pulse that is recognized as an interrupt request.	20			ns

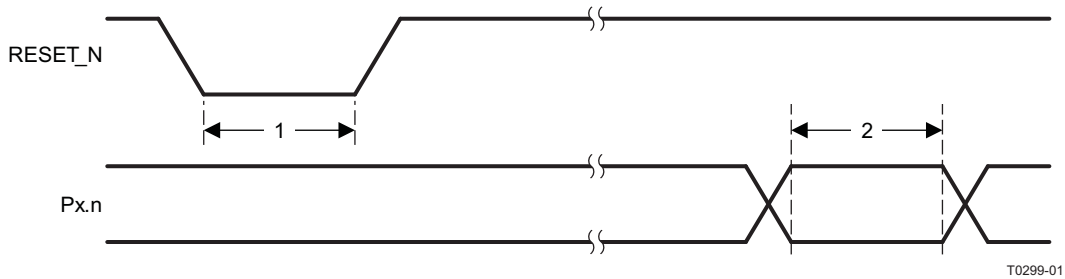
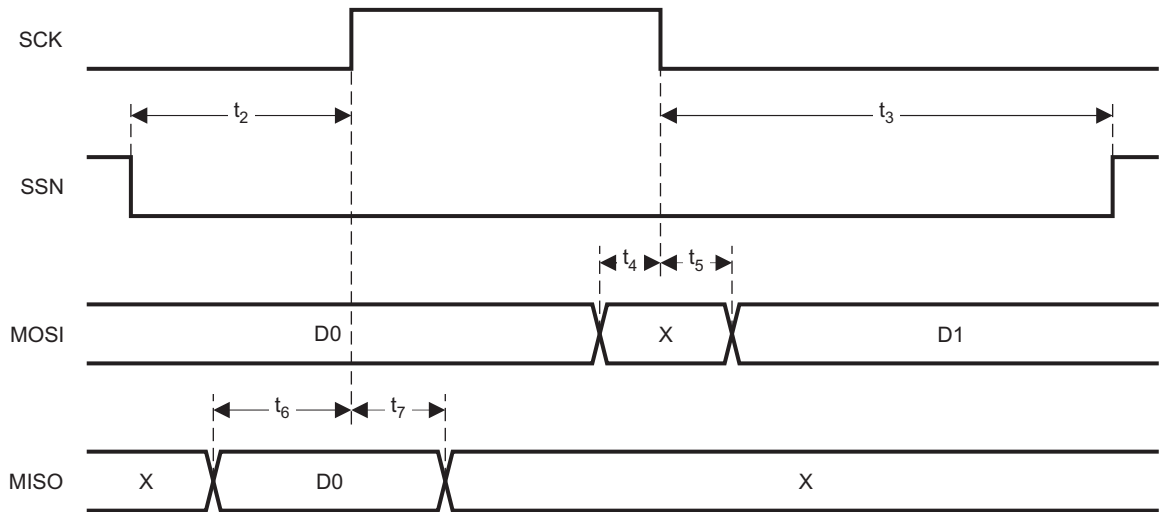

Figure 1. Control Input AC Characteristics

SPI AC CHARACTERISTICS

T_A = -40°C to 125°C, VDD = 2 V to 3.6 V, unless otherwise noted.

PARAMETER	TEST CONDITIONS	MIN	TYP	MAX	UNIT
SCK period	Master, RX and TX	250			ns
SCK duty cycle	Master		50%		
t ₂ SSN low to SCK	Master	63			ns
t ₃ SCK to SSN high	Master	63			ns
t ₄ MOSI early out	Master, load = 10 pF			7	ns
t ₅ MOSI late out	Master, load = 10 pF			10	ns
t ₆ MISO setup	Master	90			ns
t ₇ MISO hold	Master	10			ns
t ₁ SCK period	Slave, RX and TX	250			ns
SCK duty cycle	Slave		50%		
t ₂ SSN low to SCK	Slave	63			ns
t ₃ SCK to SSN high	Slave	63			ns
t ₈ MISO early out	Slave, load = 10 pF			0	ns
t ₉ MISO late out	Slave, load = 10 pF			95	ns
t ₁₀ MOSI setup	Slave	35			ns
t ₁₁ MOSI hold	Slave	10			ns
Operating frequency	Master, TX only			8	MHz
	Master, RX and TX			4	
	Slave, RX only			8	
	Slave, RX and TX			4	



T0478-01

Figure 2. SPI Master AC Characteristics

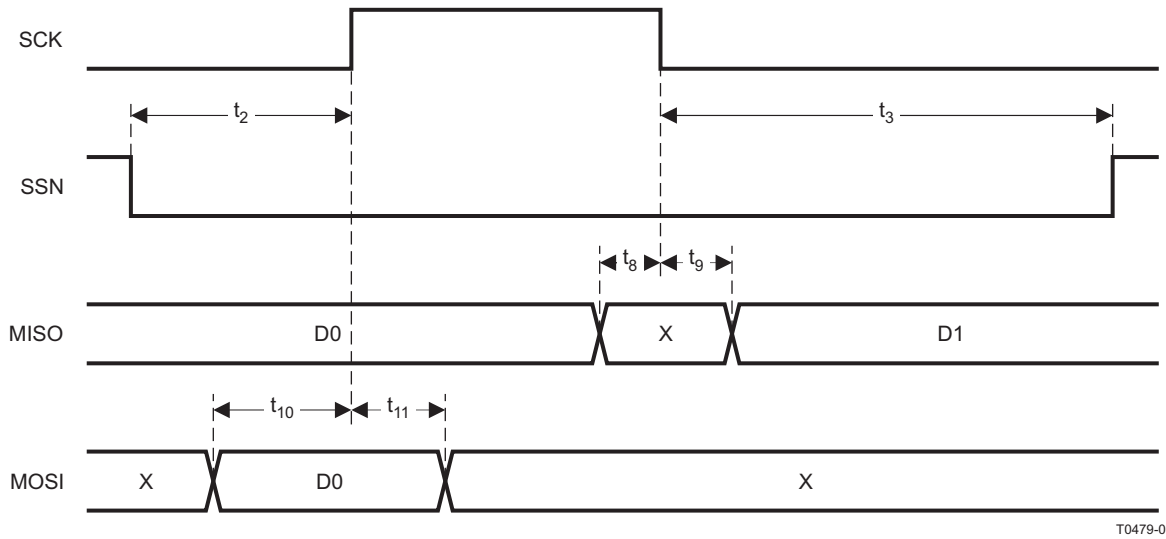

T0479-01

Figure 3. SPI Slave AC Characteristics

DEBUG INTERFACE AC CHARACTERISTICS

$T_A = -40^{\circ}\text{C}$ to 125°C , $V_{DD} = 2\text{ V}$ to 3.6 V , unless otherwise noted.

PARAMETER	TEST CONDITIONS	MIN	TYP	MAX	UNIT
$f_{\text{clk_dbg}}$ Debug clock frequency (see Figure 4)				12	MHz
t_1 Allowed high pulse on clock (see Figure 4)		35			ns
t_2 Allowed low pulse on clock (see Figure 4)		35			ns
t_3 EXT_RESET_N low to first falling edge on debug clock (see Figure 5)		167			ns
t_4 Falling edge on clock to EXT_RESET_N high (see Figure 5)		83			ns
t_5 EXT_RESET_N high to first debug command (see Figure 5)		83			ns
t_6 Debug data setup (see Figure 6)		2			ns
t_7 Debug data hold (see Figure 6)		4			ns
t_8 Clock-to-data delay (see Figure 6)	Load = 10 pF			30	ns

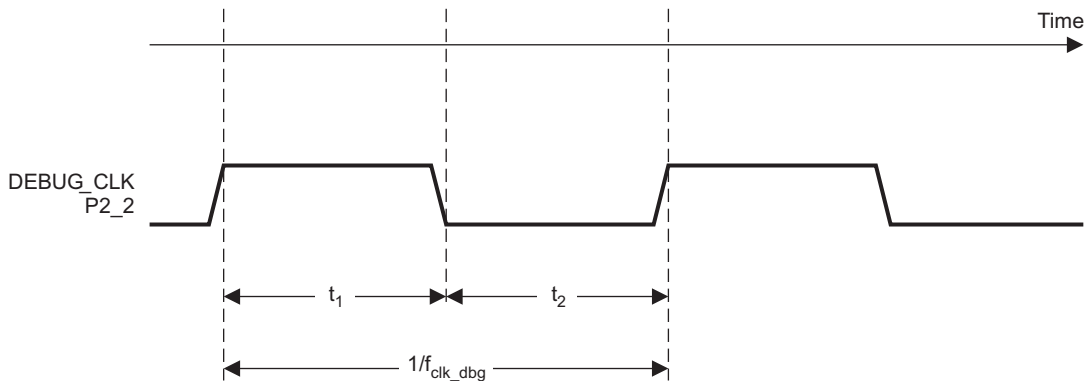

T0436-01

Figure 4. Debug Clock – Basic Timing

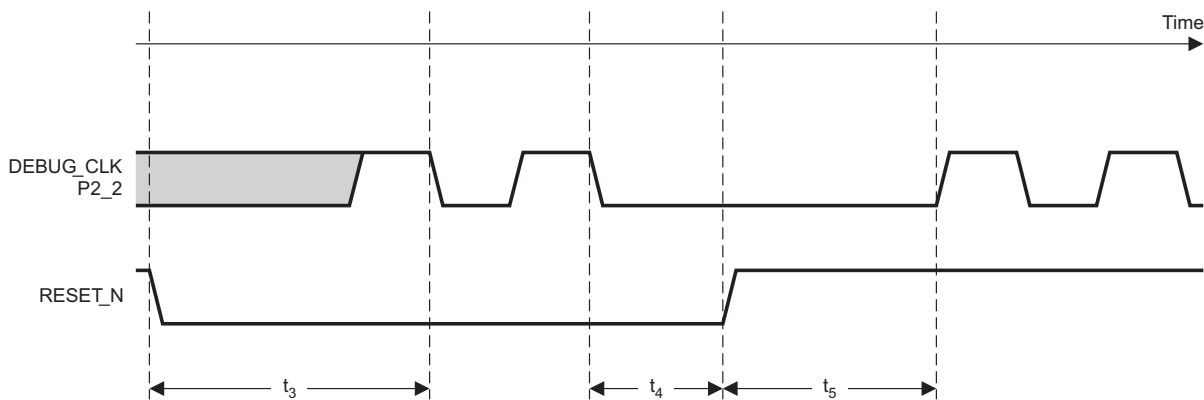

T0437-01

Figure 5. Data Setup and Hold Timing

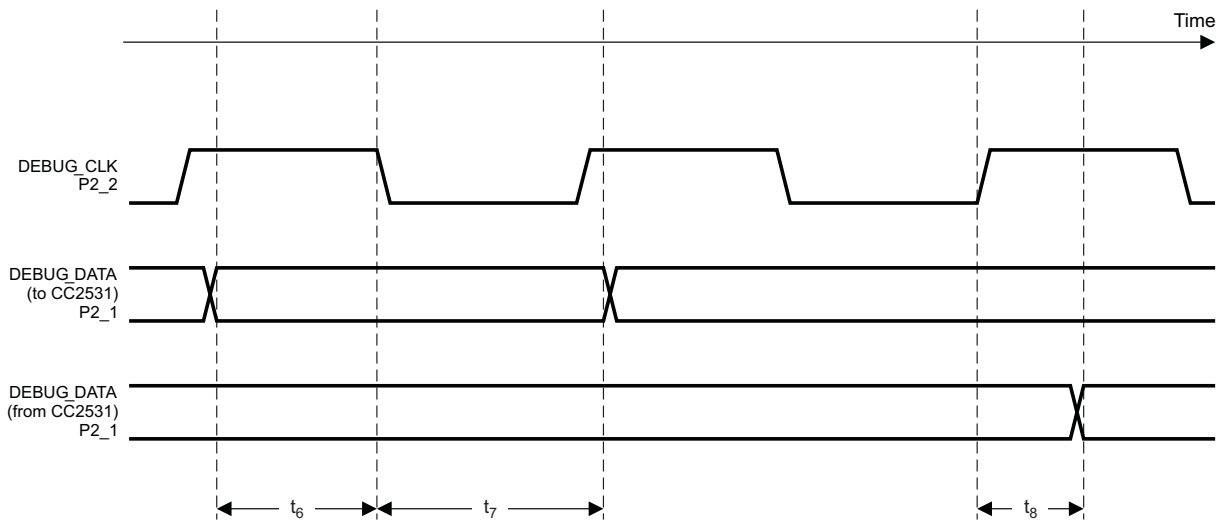

T0438-01

Figure 6. Debug Enable Timing

TIMER INPUTS AC CHARACTERISTICS

T_A = -40°C to 125°C, V_{DD} = 2 V to 3.6 V, unless otherwise noted.

PARAMETER	TEST CONDITIONS	MIN	TYP	MAX	UNIT
Input capture pulse duration	Synchronizers determine the shortest input pulse that can be recognized. The synchronizers operate at the current system clock rate (16 or 32 MHz).	1.5			t _{SYSClk}

DC CHARACTERISTICS

T_A = 25°C, V_{DD} = 3 V, unless otherwise noted.

PARAMETER	TEST CONDITIONS	MIN	TYP	MAX	UNIT
Logic-0 input voltage				0.5	V
Logic-1 input voltage		2.5			V
Logic-0 input current	Input equals 0 V	-50		50	nA
Logic-1 input current	Input equals V _{DD}	-50		50	nA
I/O-pin pullup and pulldown resistors			20		kΩ
Logic-0 output voltage, 4-mA pins	Output load 4 mA			0.5	V
Logic-1 output voltage, 4-mA pins	Output load 4 mA	2.4			V
Logic-0 output voltage, 20-mA pins	Output load 20 mA			0.5	V
Logic-1 output voltage, 20-mA pins	Output load 20 mA	2.4			V

USB INTERFACE DC CHARACTERISTICS

T_A = 25°C, V_{DD} = 3 V to 3.6 V, unless otherwise noted.

PARAMETER	TEST CONDITIONS	MIN	TYP	MAX	UNIT
USB pad voltage output, high	V _{DD} 3.6 V, 4-mA load		3.4		V
USB pad voltage output, low	V _{DD} 3.6 V, 4-mA load		0.2		V

DEVICE INFORMATION

**RHA PACKAGE
(TOP VIEW)**

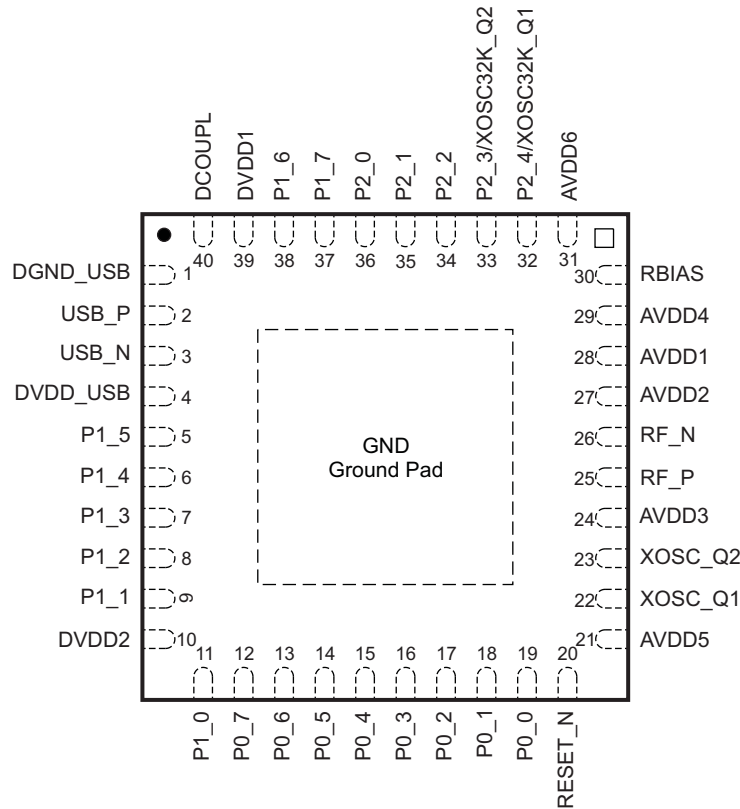

NOTE: The exposed ground pad must be connected to a solid ground plane, as this is the ground connection for the chip.

Pin Descriptions

PIN NAME	PIN	PIN TYPE	DESCRIPTION
AVDD1	28	Power (analog)	2-V–3.6-V analog power-supply connection
AVDD2	27	Power (analog)	2-V–3.6-V analog power-supply connection
AVDD3	24	Power (analog)	2-V–3.6-V analog power-supply connection
AVDD4	29	Power (analog)	2-V–3.6-V analog power-supply connection
AVDD5	21	Power (analog)	2-V–3.6-V analog power-supply connection
AVDD6	31	Power (analog)	2-V–3.6-V analog power-supply connection
DCOUP	40	Power (digital)	1.8-V digital power-supply decoupling. Do not use for supplying external circuits.
DGND_USB	1	Ground (USB pads)	USB Ground
DVDD1	39	Power (digital)	2-V–3.6-V digital power-supply connection
DVDD2	10	Power (digital)	2-V–3.6-V digital power-supply connection
DVDD_USB	4	Power (USB Pads)	3.3V USB power supply connection
GND	—	Ground	The ground pad must be connected to a solid ground plane.
P0_0	19	Digital I/O	Port 0.0
P0_1	18	Digital I/O	Port 0.1
P0_2	17	Digital I/O	Port 0.2
P0_3	16	Digital I/O	Port 0.3
P0_4	15	Digital I/O	Port 0.4
P0_5	14	Digital I/O	Port 0.5

Pin Descriptions (continued)

PIN NAME	PIN	PIN TYPE	DESCRIPTION
P0_6	13	Digital I/O	Port 0.6
P0_7	12	Digital I/O	Port 0.7
P1_0	11	Digital I/O	Port 1.0 – 20-mA drive capability
P1_1	9	Digital I/O	Port 1.1 – 20-mA drive capability
P1_2	8	Digital I/O	Port 1.2
P1_3	7	Digital I/O	Port 1.3
P1_4	6	Digital I/O	Port 1.4
P1_5	5	Digital I/O	Port 1.5
P1_6	38	Digital I/O	Port 1.6
P1_7	37	Digital I/O	Port 1.7
P2_0	36	Digital I/O	Port 2.0
P2_1	35	Digital I/O	Port 2.1
P2_2	34	Digital I/O	Port 2.2
P2_3/ XOSC32K_Q2	33	Digital I/O, analog I/O	Port 2.3/32.768 kHz XOSC
P2_4/ XOSC32K_Q1	32	Digital I/O, analog I/O	Port 2.4/32.768 kHz XOSC
RBIAS	30	Analog I/O	External precision bias resistor for reference current
RESET_N	20	Digital input	Reset, active-low
RF_N	26	RF I/O	Negative RF input signal to LNA during RX Negative RF output signal from PA during TX
RF_P	25	RF I/O	Positive RF input signal to LNA during RX Positive RF output signal from PA during TX
USB_N	3	USB I/O	USB differential data minus (D-)
USB_P	2	USB I/O	USB differential data plus (D+)
XOSC_Q1	22	Analog I/O	32-MHz crystal oscillator pin 1 or external-clock input
XOSC_Q2	23	Analog I/O	32-MHz crystal oscillator pin 2

CIRCUIT DESCRIPTION

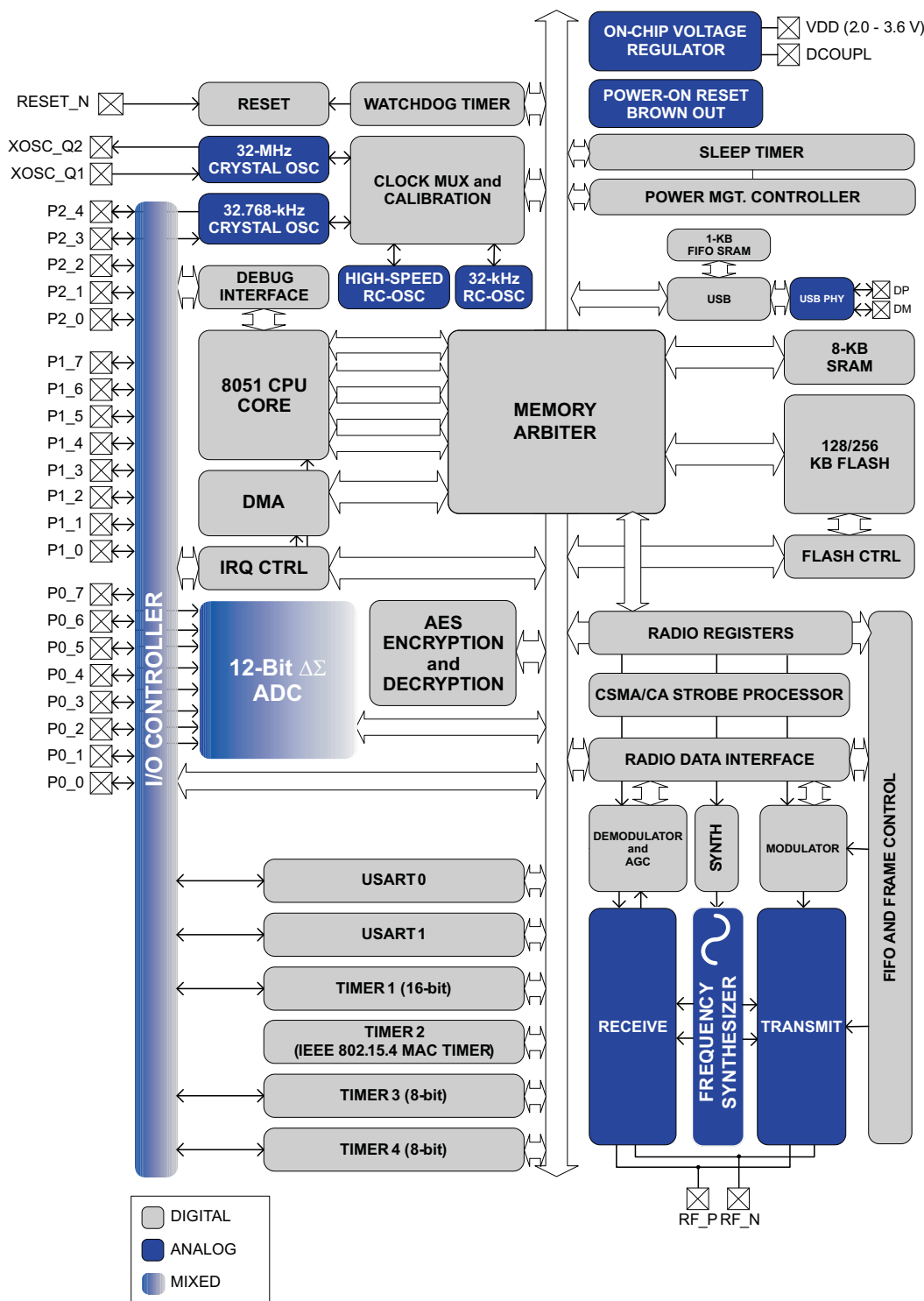

Figure 7. CC2531 Block Diagram

A block diagram of the CC2531 is shown in Figure 7. The modules can be roughly divided into one of three categories: CPU- and memory-related modules; modules related to peripherals, clocks, and power management; and radio-related modules. In the following subsections, a short description of each module that appears in Figure 7 is given.

For more details about the modules and their usage, see the corresponding chapters in the CC253x User's Guide ([SWRU191](#)).

CPU and Memory

The **8051 CPU** core used in the CC253x device family is a single-cycle 8051-compatible core. It has three different memory-access buses (SFR, DATA, and CODE/XDATA) with single-cycle access to SFR, DATA, and the main SRAM. It also includes a debug interface and an 18-input extended interrupt unit.

The **interrupt controller** services a total of 18 interrupt sources, divided into six interrupt groups, each of which is associated with one of four interrupt priorities. Any interrupt service request is serviced also when the device is in idle mode by going back to active mode. Some interrupts can also wake up the device from sleep mode (power modes 1–3).

The **memory arbiter** is at the heart of the system, as it connects the CPU and DMA controller with the physical memories and all peripherals through the SFR bus. The memory arbiter has four memory access points, access of which can map to one of three physical memories: an 8-KB SRAM, flash memory, and XREG/SFR registers. It is responsible for performing arbitration and sequencing between simultaneous memory accesses to the same physical memory.

The **8-KB SRAM** maps to the DATA memory space and to parts of the XDATA memory spaces. The 8-KB SRAM is an ultralow-power SRAM that retains its contents even when the digital part is powered off (power modes 2 and 3). This is an important feature for low-power applications.

The **256 KB flash block** provides in-circuit programmable non-volatile program memory for the device, and maps into the CODE and XDATA memory spaces. In addition to holding program code and constants, the non-volatile memory allows the application to save data that must be preserved such that it is available after restarting the device. Using this feature one can, e.g., use saved network-specific data to avoid the need for a full start-up and network find-and-join process.

Clocks and Power Management

The digital core and peripherals are powered by a 1.8-V low-dropout **voltage regulator**. It provides **power management** functionality that enables low-power operation for long battery life using different power modes. Five different **reset** sources exist to reset the device.

Peripherals

The CC2531 includes many different peripherals that allow the application designer to develop advanced applications.

The **debug interface** implements a proprietary two-wire serial interface that is used for in-circuit debugging. Through this debug interface, it is possible to perform an erasure of the entire flash memory, control which oscillators are enabled, stop and start execution of the user program, execute supplied instructions on the 8051 core, set code breakpoints, and single-step through instructions in the code. Using these techniques, it is possible to perform in-circuit debugging and external flash programming elegantly.

The device contains flash memory for storage of program code. The flash memory is programmable from the user software and through the debug interface. The **flash controller** handles writing and erasing the embedded flash memory. The flash controller allows page-wise erasure and 4-bitwise programming.

The **I/O controller** is responsible for all general-purpose I/O pins. The CPU can configure whether peripheral modules control certain pins or whether they are under software control, and if so, whether each pin is configured as an input or output and if a pullup or pulldown resistor in the pad is connected. CPU interrupts can be enabled on each pin individually. Each peripheral that connects to the I/O pins can choose between two different I/O pin locations to ensure flexibility in various applications.

A versatile five-channel **DMA controller** is available in the system, accesses memory using the XDATA memory space, and thus has access to all physical memories. Each channel (trigger, priority, transfer mode, addressing mode, source and destination pointers, and transfer count) is configured with DMA descriptors anywhere in memory. Many of the hardware peripherals (AES core, flash controller, USARTs, timers, ADC interface) achieve highly efficient operation by using the DMA controller for data transfers between SFR or XREG addresses and flash/SRAM.

Timer 1 is a 16-bit timer with timer/counter/PWM functionality. It has a programmable prescaler, a 16-bit period value, and five individually programmable counter/capture channels, each with a 16-bit compare value. Each of the counter/capture channels can be used as a PWM output or to capture the timing of edges on input signals. It can also be configured in **IR Generation Mode**, where it counts Timer 3 periods and the output is ANDed with the output of Timer 3 to generate modulated consumer IR signals with minimal CPU interaction.

Timer 2 (the MAC Timer) is specially designed for supporting an IEEE 802.15.4 MAC or other time-slotted protocol in software. The timer has a configurable timer period and a 24-bit overflow counter that can be used to keep track of the number of periods that have transpired. A 40-bit capture register is also used to record the exact time at which a start-of-frame delimiter is received/transmitted or the exact time at which transmission ends, as well as two 16-bit output compare registers and two 24-bit overflow compare registers that can send various command strobes (start RX, start TX, etc.) at specific times to the radio modules.

Timer 3 and Timer 4 are 8-bit timers with timer/counter/PWM functionality. They have a programmable prescaler, an 8-bit period value, and one programmable counter channel with an 8-bit compare value. Each of the counter channels can be used as a PWM output.

The **sleep timer** is an ultralow-power timer that counts 32-kHz crystal oscillator or 32-kHz RC oscillator periods. The sleep timer runs continuously in all operating modes except power mode 3 (PM3). Typical applications of this timer are as a real-time counter or as a wake-up timer to come out of power mode 1 (PM1) or 2 (PM2).

The **ADC** supports 7 to 12 bits of resolution in a 30-kHz to 4-kHz bandwidth, respectively. DC and audio conversions with up to eight input channels (Port 0) are possible. The inputs can be selected as single-ended or differential. The reference voltage can be internal, AVDD, or a single-ended or differential external signal. The ADC also has a temperature-sensor input channel. The ADC can automate the process of periodic sampling or conversion over a sequence of channels.

The **random-number generator** uses a 16-bit LFSR to generate pseudorandom numbers, which can be read by the CPU or used directly by the command strobe processor. It can be seeded with random data from noise in the radio ADC.

The **AES encryption/decryption core** allows the user to encrypt and decrypt data using the AES algorithm with 128-bit keys. The core is able to support the AES operations required by IEEE 802.15.4 MAC security, the ZigBee network layer, and the application layer.

A built-in **watchdog timer** allows the CC2531 to reset itself in case the firmware hangs. When enabled by software, the watchdog timer must be cleared periodically; otherwise, it resets the device when it times out. It can alternatively be configured for use as a general 32-kHz timer.

USART 0 and USART 1 are each configurable as either a SPI master/slave or a UART. They provide double buffering on both RX and TX and hardware flow control, and are thus well suited to high-throughput full-duplex applications. Each has its own high-precision baud-rate generator, thus leaving the ordinary timers free for other uses.

The **USB** device operates at full-speed, 12-Mbps transfer rate. The controller has 5 bidirectional endpoints in addition to control endpoint 0. The endpoints support bulk, interrupt, and isochronous operation for implementation of a wide range of applications. The 1024 bytes of dedicated, flexible FIFO memory combined with DMA access ensures that a minimum of CPU involvement is needed for USB communication.

Radio

The CC2531 features an IEEE 802.15.4-compliant radio transceiver. The RF core controls the analog radio modules. In addition, it provides an interface between the MCU and the radio which makes it possible to issue commands, read status, and automate and sequence radio events. The radio also includes a packet-filtering and address-recognition module.

TYPICAL CHARACTERISTICS

RX CURRENT (–100-dBm INPUT)
vs
TEMPERATURE

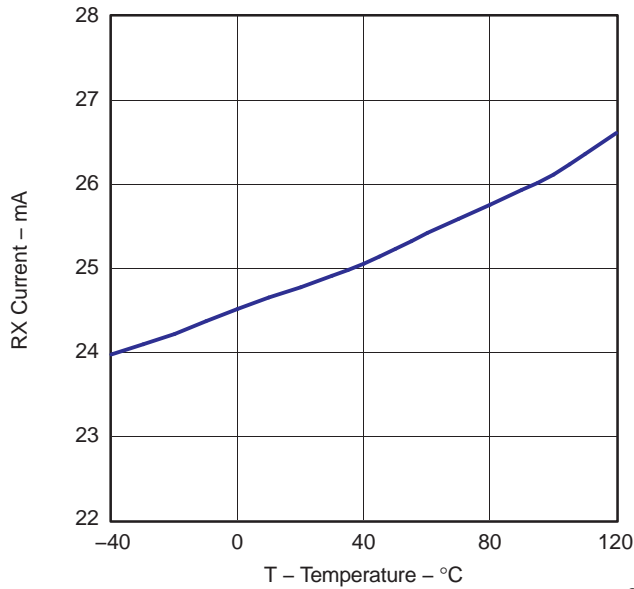

G001

Figure 8.

TX CURRENT (TXPOWER = 0xF5)
vs
TEMPERATURE

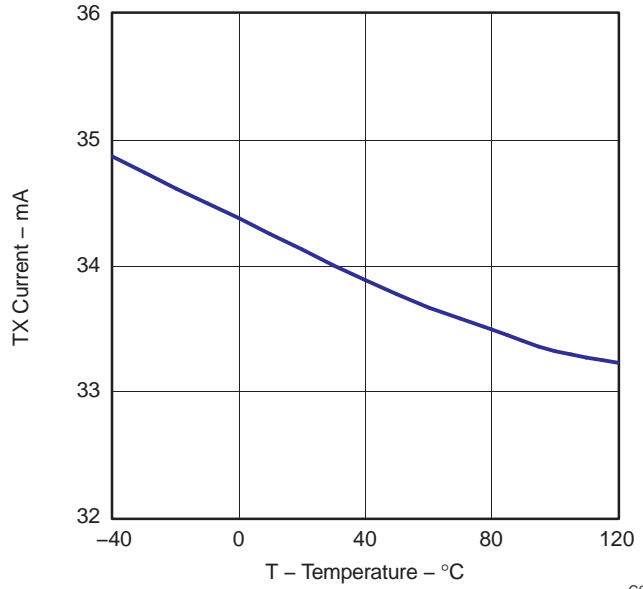

G002

Figure 9.

RX CURRENT (–100-dBm INPUT)
vs
SUPPLY VOLTAGE

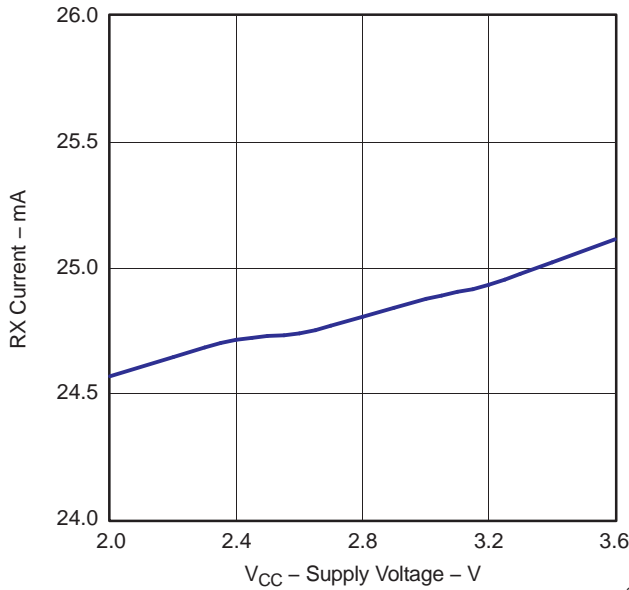

G003

Figure 10.

TX CURRENT (TXPOWER = 0xF5)
vs
SUPPLY VOLTAGE

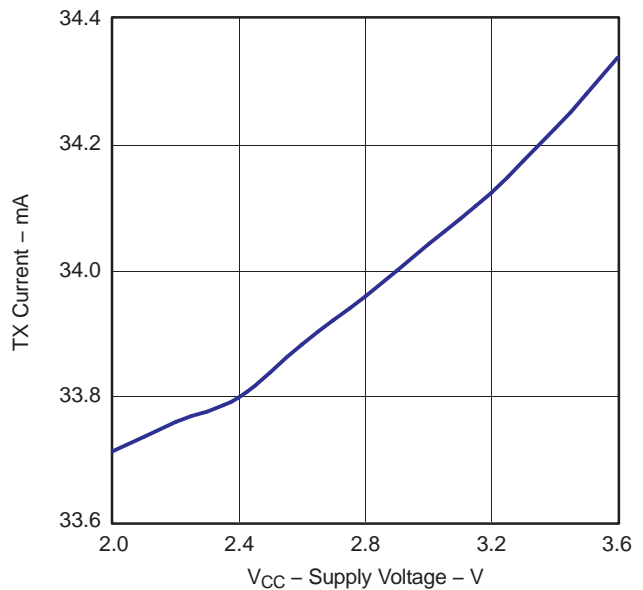

G004

Figure 11.

TYPICAL CHARACTERISTICS (continued)

**OUTPUT POWER (TXPOWER = 0xF5)
vs
FREQUENCY**

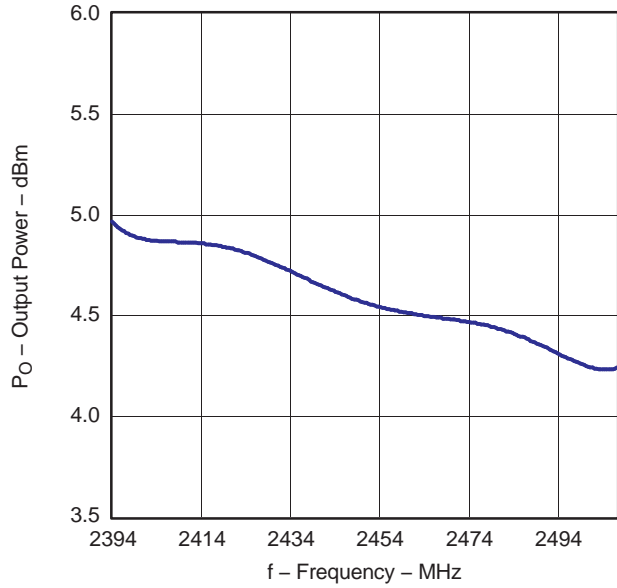

G005

Figure 12.

**INTERFERER REJECTION (802.15.4 INTERFERER)
vs
INTERFERER FREQUENCY (CARRIER AT -82 dBm, 2440 MHz)**

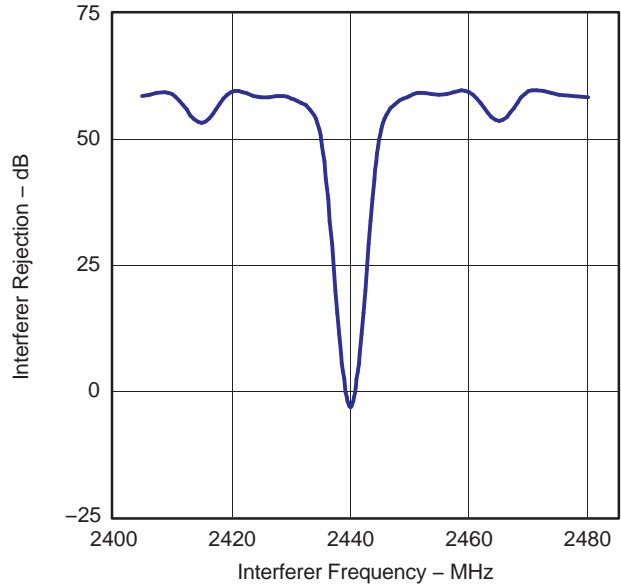

G006

Figure 13.

**SENSITIVITY
vs
TEMPERATURE**

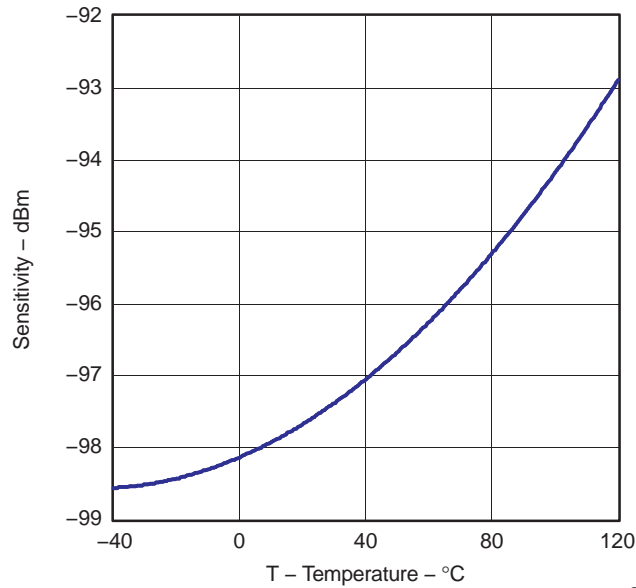

G007

Figure 14.

**OUTPUT POWER (TXPOWER = 0xF5)
vs
TEMPERATURE**

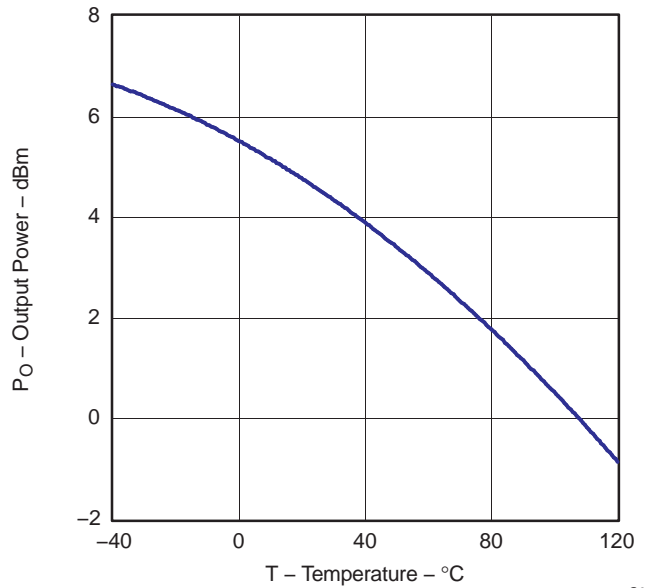

G008

Figure 15.

TYPICAL CHARACTERISTICS (continued)

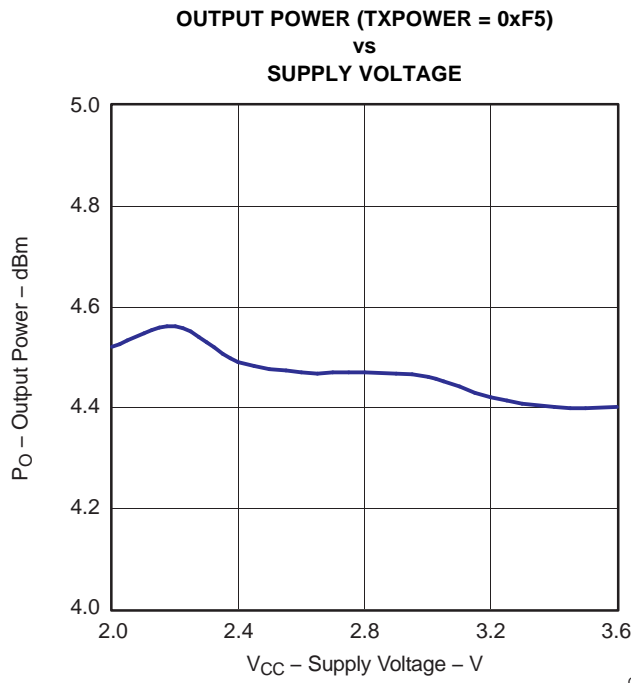

Figure 16.

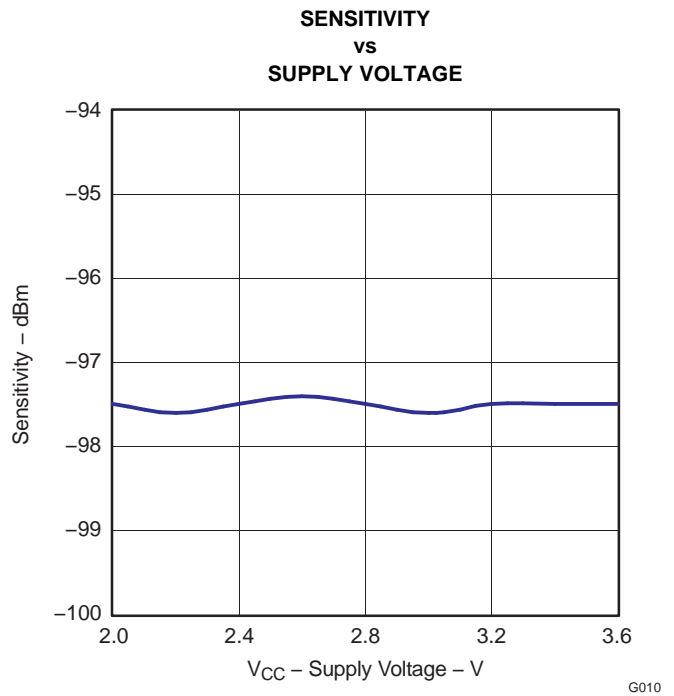

Figure 17.

Table 1. Recommended Output Power Settings⁽¹⁾

TXPOWER Register Setting	Typical Output Power (dBm)	Typical Current Consumption (mA)
0xF5	4.5	34
0xE5	2.5	31
0xD5	1	29
0xC5	-0.5	28
0xB5	-1.5	27
0xA5	-3	27
0x95	-4	26
0x85	-6	26
0x75	-8	25
0x65	-10	25
0x55	-12	25
0x45	-14	25
0x35	-16	25
0x25	-18	24
0x15	-20	24
0x05	-22	23
0x05 and TXCTRL = 0x09	-28	23

(1) Measured on Texas Instruments CC2530 EM reference design with T_A = 25°C, V_{DD} = 3 V, and f_c = 2440 MHz, unless otherwise noted.

Table 2. Overview of External Components (Excluding Supply Decoupling Capacitors)

Component	Description	Value
C21	USB D– decoupling	47 pF
C31	USB D+ decoupling	47 pF
C41	Decoupling capacitor for USB pad power supply	10 pF
C221	32-MHz xtal-loading capacitor	27 pF
C231	32-MHz xtal-loading capacitor	27 pF
C251	Part of the RF matching network	18 pF
C252	Part of the RF matching network	1 pF
C253	Part of the RF matching network	2.2 pF
C261	Part of the RF matching network	18 pF
C262	Part of the RF matching network	1 pF
C321	32-kHz xtal-loading capacitor	15 pF
C331	32-kHz xtal-loading capacitor	15 pF
C401	Decoupling capacitor for the internal digital regulator	1 μF
L252	Part of the RF matching network	2 nH
L261	Part of the RF matching network	2 nH
R21	USB D– series resistor	33 Ω
R31	USB D+ series resistor	33 Ω
R32	USB D+ pullup resistor to signal full-speed device	1.5 kΩ
R301	Resistor used for internal biasing	56 kΩ

Input/Output Matching

When using an unbalanced antenna such as a monopole, a balun should be used to optimize performance. The balun can be implemented using low-cost discrete inductors and capacitors. The recommended balun shown consists of C262, L261, C252, and L252.

If a balanced antenna such as a folded dipole is used, the balun can be omitted.

Crystal

An external 32-MHz crystal, XTAL1, with two loading capacitors (C221 and C231) is used for the 32-MHz crystal oscillator. See the [32-MHz Crystal Oscillator](#) section for details. The load capacitance seen by the 32-MHz crystal is given by:

$$C_L = \frac{1}{\frac{1}{C_{221}} + \frac{1}{C_{231}}} + C_{\text{parasitic}} \quad (1)$$

XTAL2 is an optional 32.768-kHz crystal, with two loading capacitors (C321 and C331) used for the 32.768-kHz crystal oscillator. The 32.768-kHz crystal oscillator is used in applications where both low sleep-current consumption and accurate wake-up times are needed. The load capacitance seen by the 32.768-kHz crystal is given by:

$$C_L = \frac{1}{\frac{1}{C_{321}} + \frac{1}{C_{331}}} + C_{\text{parasitic}} \quad (2)$$

A series resistor may be used to comply with the ESR requirement.

On-Chip 1.8-V Voltage-Regulator Decoupling

The 1.8-V on-chip voltage regulator supplies the 1.8-V digital logic. This regulator requires a decoupling capacitor (C401) for stable operation.

Power-Supply Decoupling and Filtering

Proper power-supply decoupling must be used for optimum performance. The placement and size of the decoupling capacitors and the power supply filtering are important to achieve the best performance in an application. TI provides a recommended compact reference design for the user to follow.

References

1. IEEE Std. 802.15.4-2006: Wireless Medium Access Control (MAC) and Physical Layer (PHY) Specifications for Low-Rate Wireless Personal Area Networks (LR-WPANS)
<http://standards.ieee.org/getieee802/download/802.15.4-2006.pdf>
2. CC253x User's Guide – CC253x System-on-Chip Solution for 2.4 GHz IEEE 802.15.4 and ZigBee Applications (SWRU191)
3. Universal Serial Bus Revision 2.0 Specification http://www.usb.org/developers/docs/usb_20_052709.zip

Additional Information

Texas Instruments offers a wide selection of cost-effective, low-power RF solutions for proprietary and standard-based wireless applications for use in industrial and consumer applications. The selection includes RF transceivers, RF transmitters, RF front ends, and System-on-Chips as well as various software solutions for the sub-1-GHz and 2.4-GHz frequency bands.

In addition, Texas Instruments provides a large selection of support collateral such as development tools, technical documentation, reference designs, application expertise, customer support, third-party and university programs.

The Low-Power RF E2E Online Community provides technical support forums, videos and blogs, and the chance to interact with engineers from all over the world.

With a broad selection of product solutions, end application possibilities, and a range of technical support, Texas Instruments offers the broadest low-power RF portfolio.

Texas Instruments Low-Power RF Web Site

Texas Instruments' Low-Power RF Web site has all the latest products, application and design notes, FAQ section, news and events updates. Go to www.ti.com/lprf.

Low-Power RF Online Community

- Forums, videos, and blogs
- RF design help
- E2E interaction

Join at: www.ti.com/lprf-forum.

Texas Instruments Low-Power RF Developer Network

Texas Instruments has launched an extensive network of low-power RF development partners to help customers speed up their application development. The network consists of recommended companies, RF consultants, and independent design houses that provide a series of hardware module products and design services, including:

- RF circuit, low-power RF, and ZigBee design services
- Low-power RF and ZigBee module solutions and development tools
- RF certification services and RF circuit manufacturing

For help with modules, engineering services or development tools:

Search the [Low-Power RF Developer Network](http://www.ti.com/lprfnetwork) to find a suitable partner. www.ti.com/lprfnetwork

Low-Power RF eNewsletter

The Low-Power RF eNewsletter is up-to-date on new products, news releases, developers' news, and other news and events associated with low-power RF products from TI. The Low-Power RF eNewsletter articles include links to get more online information.

Sign up at: www.ti.com/lprfnewsletter

REVISION HISTORY

Changes from Revision Original (September 2009) to Revision A	Page
• Changed recommendation for single-crystal implementations to asynchronous networks.	1
• Added F128 version of CC2531 to data sheet.	1
• Added number of erase cycles and page size for flash.	4
• Added number of erase cycles and page size for flash.	5
• Updated ESR for 32 kHz crystal.	8
• Updated voltage coefficient for temperature sensor.	9
• Changed SPI AC characteristics SSN low from SCK negative edge to SCK positive edge and split it into separate master and slave figures.	12
• Corrected description of Timer 2 (MAC Timer).	20
• Improved readability of sleep timer description.	20
• Removed sentence that pseudorandom data can be used for security.	20

PACKAGING INFORMATION

Orderable Device	Status ⁽¹⁾	Package Type	Package Drawing	Pins	Package Qty	Eco Plan ⁽²⁾	Lead/ Ball Finish	MSL Peak Temp ⁽³⁾	Samples (Requires Login)
CC2531F128RHAR	ACTIVE	VQFN	RHA	40	2500	Green (RoHS & no Sb/Br)	CU NIPDAU	Level-3-260C-168 HR	Purchase Samples
CC2531F128RHAT	ACTIVE	VQFN	RHA	40	250	Green (RoHS & no Sb/Br)	CU NIPDAU	Level-3-260C-168 HR	Request Free Samples
CC2531F256RHAR	ACTIVE	VQFN	RHA	40	2500	Green (RoHS & no Sb/Br)	CU NIPDAU	Level-3-260C-168 HR	Purchase Samples
CC2531F256RHAT	ACTIVE	VQFN	RHA	40	250	Green (RoHS & no Sb/Br)	CU NIPDAU	Level-3-260C-168 HR	Request Free Samples

⁽¹⁾ The marketing status values are defined as follows:

ACTIVE: Product device recommended for new designs.

LIFEBUY: TI has announced that the device will be discontinued, and a lifetime-buy period is in effect.

NRND: Not recommended for new designs. Device is in production to support existing customers, but TI does not recommend using this part in a new design.

PREVIEW: Device has been announced but is not in production. Samples may or may not be available.

OBsolete: TI has discontinued the production of the device.

⁽²⁾ Eco Plan - The planned eco-friendly classification: Pb-Free (RoHS), Pb-Free (RoHS Exempt), or Green (RoHS & no Sb/Br) - please check <http://www.ti.com/productcontent> for the latest availability information and additional product content details.

TBD: The Pb-Free/Green conversion plan has not been defined.

Pb-Free (RoHS): TI's terms "Lead-Free" or "Pb-Free" mean semiconductor products that are compatible with the current RoHS requirements for all 6 substances, including the requirement that lead not exceed 0.1% by weight in homogeneous materials. Where designed to be soldered at high temperatures, TI Pb-Free products are suitable for use in specified lead-free processes.

Pb-Free (RoHS Exempt): This component has a RoHS exemption for either 1) lead-based flip-chip solder bumps used between the die and package, or 2) lead-based die adhesive used between the die and leadframe. The component is otherwise considered Pb-Free (RoHS compatible) as defined above.

Green (RoHS & no Sb/Br): TI defines "Green" to mean Pb-Free (RoHS compatible), and free of Bromine (Br) and Antimony (Sb) based flame retardants (Br or Sb do not exceed 0.1% by weight in homogeneous material)

⁽³⁾ MSL, Peak Temp. -- The Moisture Sensitivity Level rating according to the JEDEC industry standard classifications, and peak solder temperature.

Important Information and Disclaimer: The information provided on this page represents TI's knowledge and belief as of the date that it is provided. TI bases its knowledge and belief on information provided by third parties, and makes no representation or warranty as to the accuracy of such information. Efforts are underway to better integrate information from third parties. TI has taken and continues to take reasonable steps to provide representative and accurate information but may not have conducted destructive testing or chemical analysis on incoming materials and chemicals. TI and TI suppliers consider certain information to be proprietary, and thus CAS numbers and other limited information may not be available for release.

In no event shall TI's liability arising out of such information exceed the total purchase price of the TI part(s) at issue in this document sold by TI to Customer on an annual basis.

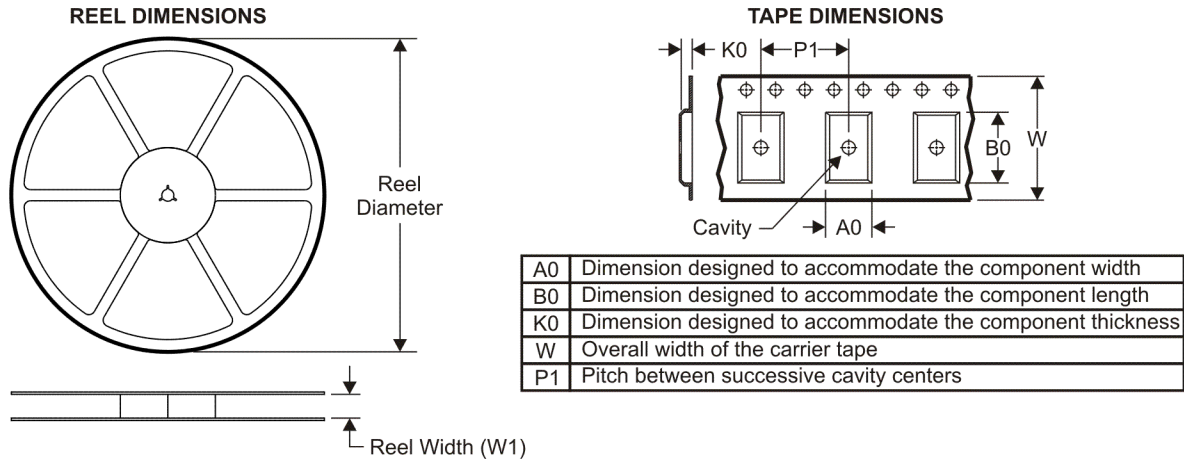
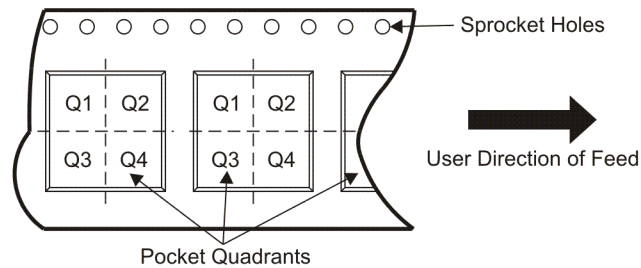
TAPE AND REEL INFORMATION

QUADRANT ASSIGNMENTS FOR PIN 1 ORIENTATION IN TAPE

*All dimensions are nominal

Device	Package Type	Package Drawing	Pins	SPQ	Reel Diameter (mm)	Reel Width W1 (mm)	A0 (mm)	B0 (mm)	K0 (mm)	P1 (mm)	W (mm)	Pin1 Quadrant
CC2531F128RHAR	VQFN	RHA	40	2500	330.0	16.4	6.3	6.3	1.5	12.0	16.0	Q2
CC2531F128RHAT	VQFN	RHA	40	250	330.0	16.4	6.3	6.3	1.5	12.0	16.0	Q2
CC2531F256RHAR	VQFN	RHA	40	2500	330.0	16.4	6.3	6.3	1.5	12.0	16.0	Q2
CC2531F256RHAT	VQFN	RHA	40	250	330.0	16.4	6.3	6.3	1.5	12.0	16.0	Q2

TAPE AND REEL BOX DIMENSIONS

*All dimensions are nominal

Device	Package Type	Package Drawing	Pins	SPQ	Length (mm)	Width (mm)	Height (mm)
CC2531F128RHAR	VQFN	RHA	40	2500	333.2	345.9	28.6
CC2531F128RHAT	VQFN	RHA	40	250	333.2	345.9	28.6
CC2531F256RHAR	VQFN	RHA	40	2500	333.2	345.9	28.6
CC2531F256RHAT	VQFN	RHA	40	250	333.2	345.9	28.6

RHA (S-PVQFN-N40)

PLASTIC QUAD FLATPACK NO-LEAD

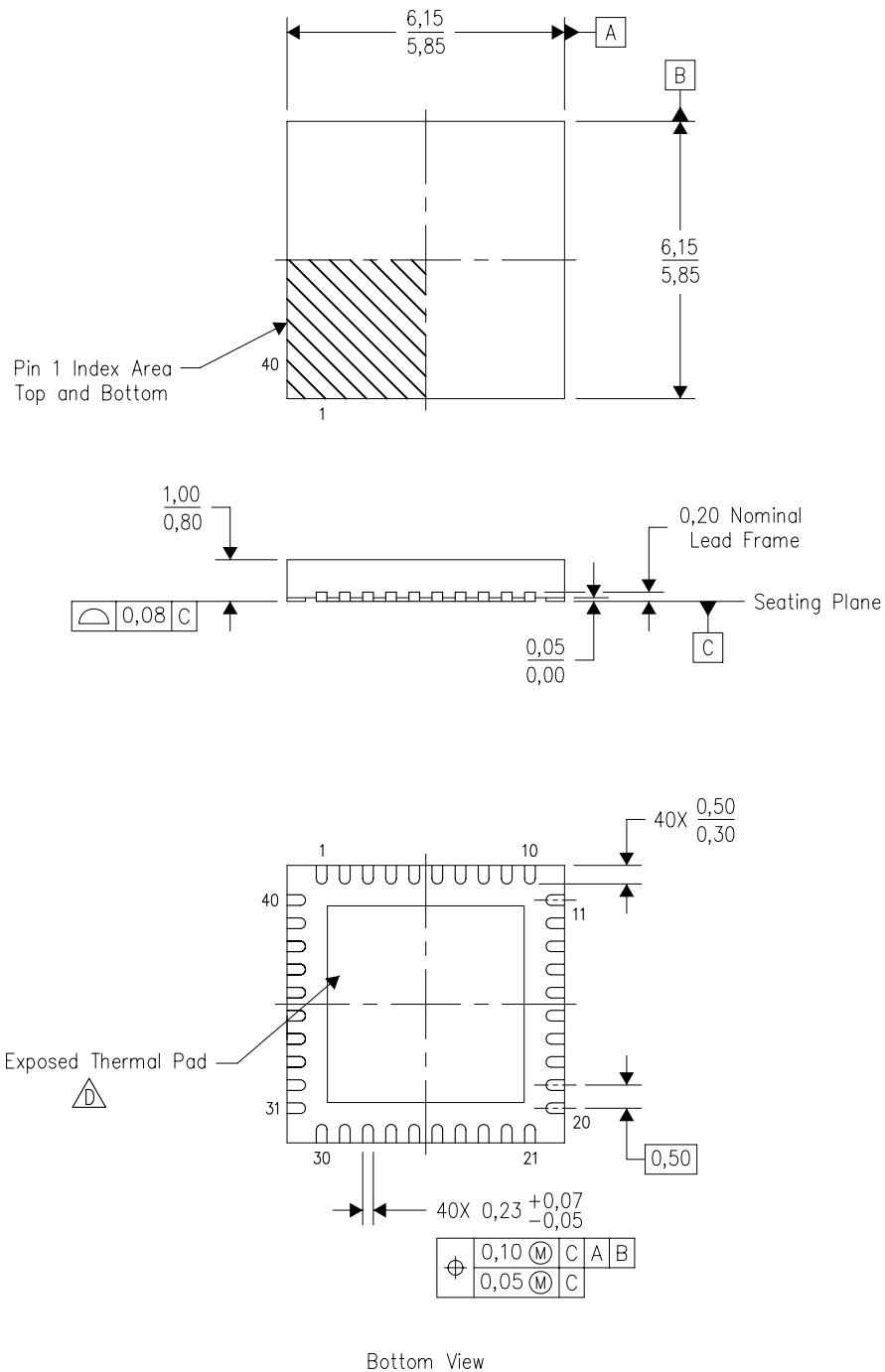

Bottom View

4204276/D 08/10

- NOTES:
- A. All linear dimensions are in millimeters. Dimensioning and tolerancing per ASME Y14.5M-1994.
 - B. This drawing is subject to change without notice.
 - C. QFN (Quad Flatpack No-Lead) Package configuration.
 -  The package thermal pad must be soldered to the board for thermal and mechanical performance. See the Product Data Sheet for details regarding the exposed thermal pad dimensions.
 - E. Package complies to JEDEC MO-220 variation VJJD-2.

THERMAL PAD MECHANICAL DATA

RHA (S-PVQFN-N40)

PLASTIC QUAD FLATPACK NO-LEAD

THERMAL INFORMATION

This package incorporates an exposed thermal pad that is designed to be attached directly to an external heatsink. The thermal pad must be soldered directly to the printed circuit board (PCB). After soldering, the PCB can be used as a heatsink. In addition, through the use of thermal vias, the thermal pad can be attached directly to the appropriate copper plane shown in the electrical schematic for the device, or alternatively, can be attached to a special heatsink structure designed into the PCB. This design optimizes the heat transfer from the

For information on the Quad Flatpack No-Lead (QFN) package and its advantages, refer to Application Report, QFN/SON PCB Attachment, Texas Instruments Literature No. SLUA271. This document is available at www.ti.com.

The exposed thermal pad dimensions for this package are shown in the following illustration.

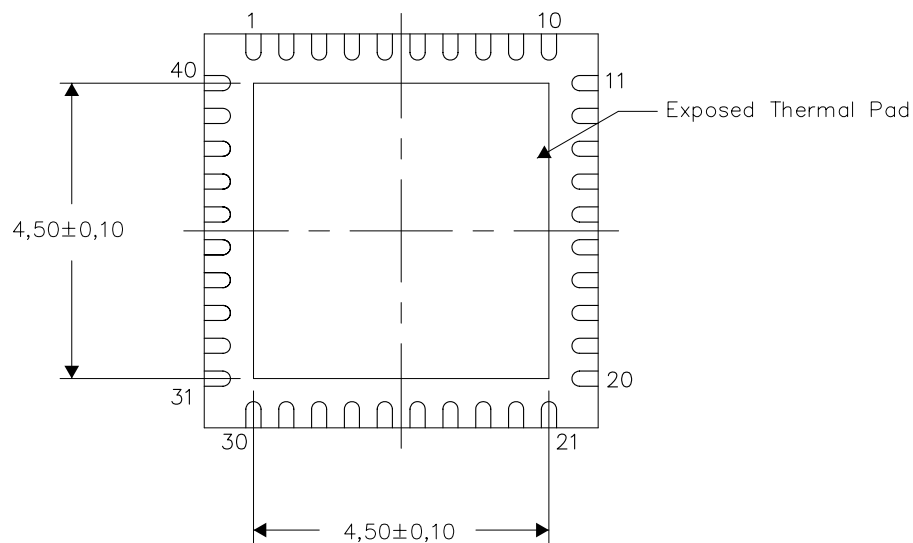

Bottom View

Exposed Thermal Pad Dimensions

4206355-4/L 08/10

NOTES: A. All linear dimensions are in millimeters

RHA (S-PVQFN-N40)

PLASTIC QUAD FLATPACK NO-LEAD

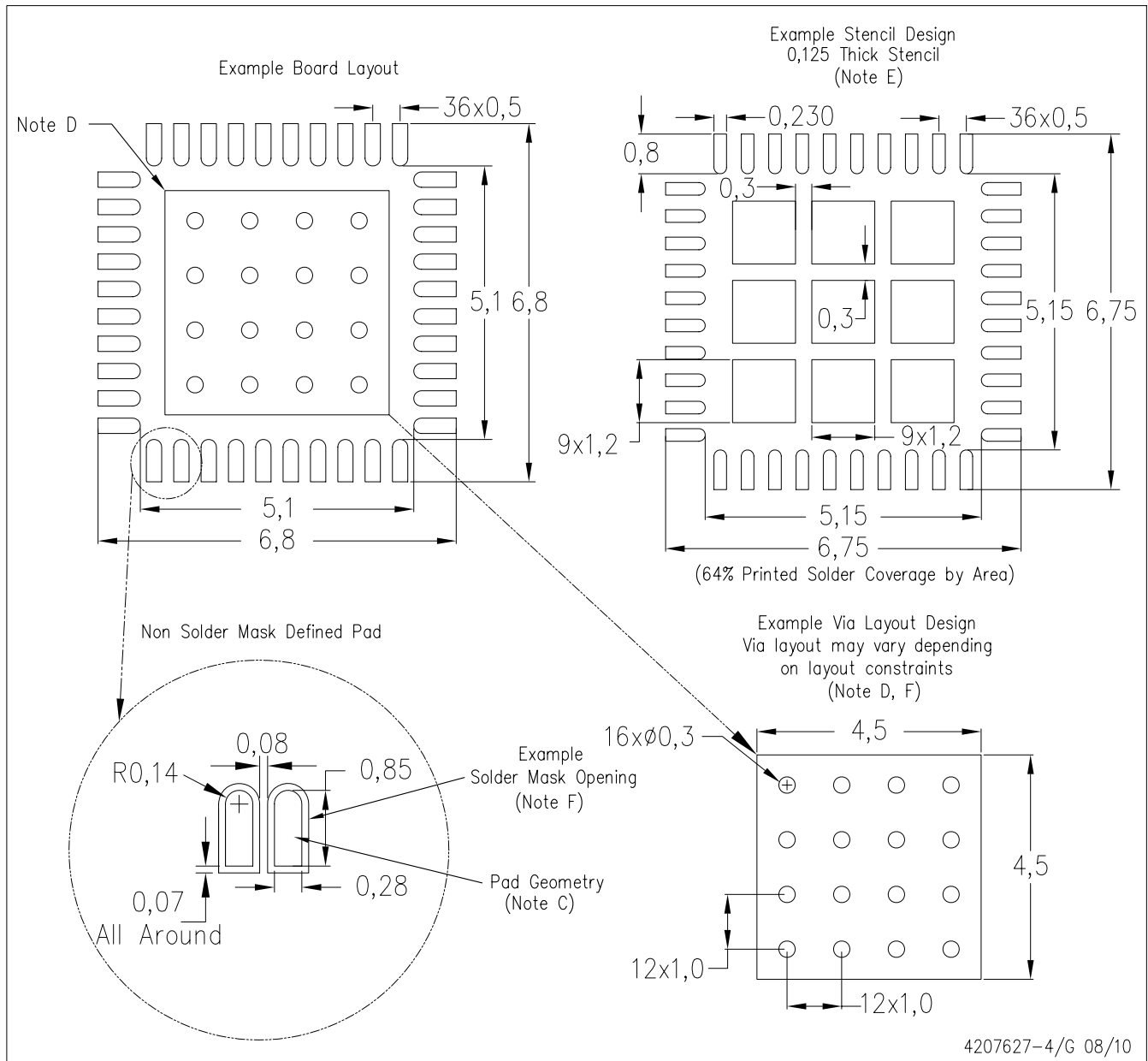

- NOTES:
- A. All linear dimensions are in millimeters.
 - B. This drawing is subject to change without notice.
 - C. Publication IPC-7351 is recommended for alternate designs.
 - D. This package is designed to be soldered to a thermal pad on the board. Refer to Application Note, Quad Flat-Pack Packages, Texas Instruments Literature No. SLUA271, and also the Product Data Sheets for specific thermal information, via requirements, and recommended board layout. These documents are available at www.ti.com <<http://www.ti.com>>.
 - E. Laser cutting apertures with trapezoidal walls and also rounding corners will offer better paste release. Customers should contact their board assembly site for stencil design recommendations. Refer to IPC 7525 for stencil design considerations.
 - F. Customers should contact their board fabrication site for recommended solder mask tolerances and via tenting recommendations for vias placed in the thermal pad.

IMPORTANT NOTICE

Texas Instruments Incorporated and its subsidiaries (TI) reserve the right to make corrections, modifications, enhancements, improvements, and other changes to its products and services at any time and to discontinue any product or service without notice. Customers should obtain the latest relevant information before placing orders and should verify that such information is current and complete. All products are sold subject to TI's terms and conditions of sale supplied at the time of order acknowledgment.

TI warrants performance of its hardware products to the specifications applicable at the time of sale in accordance with TI's standard warranty. Testing and other quality control techniques are used to the extent TI deems necessary to support this warranty. Except where mandated by government requirements, testing of all parameters of each product is not necessarily performed.

TI assumes no liability for applications assistance or customer product design. Customers are responsible for their products and applications using TI components. To minimize the risks associated with customer products and applications, customers should provide adequate design and operating safeguards.

TI does not warrant or represent that any license, either express or implied, is granted under any TI patent right, copyright, mask work right, or other TI intellectual property right relating to any combination, machine, or process in which TI products or services are used. Information published by TI regarding third-party products or services does not constitute a license from TI to use such products or services or a warranty or endorsement thereof. Use of such information may require a license from a third party under the patents or other intellectual property of the third party, or a license from TI under the patents or other intellectual property of TI.

Reproduction of TI information in TI data books or data sheets is permissible only if reproduction is without alteration and is accompanied by all associated warranties, conditions, limitations, and notices. Reproduction of this information with alteration is an unfair and deceptive business practice. TI is not responsible or liable for such altered documentation. Information of third parties may be subject to additional restrictions.

Resale of TI products or services with statements different from or beyond the parameters stated by TI for that product or service voids all express and any implied warranties for the associated TI product or service and is an unfair and deceptive business practice. TI is not responsible or liable for any such statements.

TI products are not authorized for use in safety-critical applications (such as life support) where a failure of the TI product would reasonably be expected to cause severe personal injury or death, unless officers of the parties have executed an agreement specifically governing such use. Buyers represent that they have all necessary expertise in the safety and regulatory ramifications of their applications, and acknowledge and agree that they are solely responsible for all legal, regulatory and safety-related requirements concerning their products and any use of TI products in such safety-critical applications, notwithstanding any applications-related information or support that may be provided by TI. Further, Buyers must fully indemnify TI and its representatives against any damages arising out of the use of TI products in such safety-critical applications.

TI products are neither designed nor intended for use in military/aerospace applications or environments unless the TI products are specifically designated by TI as military-grade or "enhanced plastic." Only products designated by TI as military-grade meet military specifications. Buyers acknowledge and agree that any such use of TI products which TI has not designated as military-grade is solely at the Buyer's risk, and that they are solely responsible for compliance with all legal and regulatory requirements in connection with such use.

TI products are neither designed nor intended for use in automotive applications or environments unless the specific TI products are designated by TI as compliant with ISO/TS 16949 requirements. Buyers acknowledge and agree that, if they use any non-designated products in automotive applications, TI will not be responsible for any failure to meet such requirements.

Following are URLs where you can obtain information on other Texas Instruments products and application solutions:

Products		Applications	
Amplifiers	amplifier.ti.com	Audio	www.ti.com/audio
Data Converters	dataconverter.ti.com	Automotive	www.ti.com/automotive
DLP® Products	www.dlp.com	Communications and Telecom	www.ti.com/communications
DSP	dsp.ti.com	Computers and Peripherals	www.ti.com/computers
Clocks and Timers	www.ti.com/clocks	Consumer Electronics	www.ti.com/consumer-apps
Interface	interface.ti.com	Energy	www.ti.com/energy
Logic	logic.ti.com	Industrial	www.ti.com/industrial
Power Mgmt	power.ti.com	Medical	www.ti.com/medical
Microcontrollers	microcontroller.ti.com	Security	www.ti.com/security
RFID	www.ti-rfid.com	Space, Avionics & Defense	www.ti.com/space-avionics-defense
RF/IF and ZigBee® Solutions	www.ti.com/lprf	Video and Imaging	www.ti.com/video
		Wireless	www.ti.com/wireless-apps