

Table of Contents

KEYWORDS	1
1 INTRODUCTION	1
TABLE OF CONTENTS	2
2 ABBREVIATIONS	2
3 DESCRIPTION OF THE ANTENNA DESIGN	3
3.1 IMPLEMENTATION OF THE ANTENNA	3
4 MEASUREMENT RESULTS	5
4.1 RADIATION PATTERN.....	5
4.2 BANDWIDTH.....	11
4.3 HARMONIC EMISSION	11
4.4 TX SPURIOUS EMISSION 30 - 1 GHZ.....	12
4.5 VCO LEAKAGE	14
5 COMPLIANCE WITH REGULATORY STANDARDS	14
6 CONCLUSION	14
7 REFERENCES	15
8 APPENDIX A	16
9 GENERAL INFORMATION	17
9.1 DOCUMENT HISTORY.....	17

2 Abbreviations

ETSI	European Telecommunications Standards Institute
HP	Horizontal Polarization
ISM	Industrial, Scientific, Medical
NM	Not Mounted
PCB	Printed Circuit Board
SoC	System on Chip
VP	Vertical Polarization

3 Description of the Antenna Design

The antenna solution implemented on the CC1111 USB dongle consists of a chip antenna [5] from Johanson Technology [6] in conjunction with a special PCB trace. See section 8 for detailed information about this chip antenna. Two matching components are used to ensure optimum performance at the desired frequency. In addition to the matching components, the length of the PCB trace can be used to tune the resonance frequency.

3.1 Implementation of the Antenna

It is important to make an exact copy of the PCB trace to obtain optimum performance. Figure 2 and Table 1 show the recommended dimensions of the PCB trace for a center frequency at 866.5 MHz.

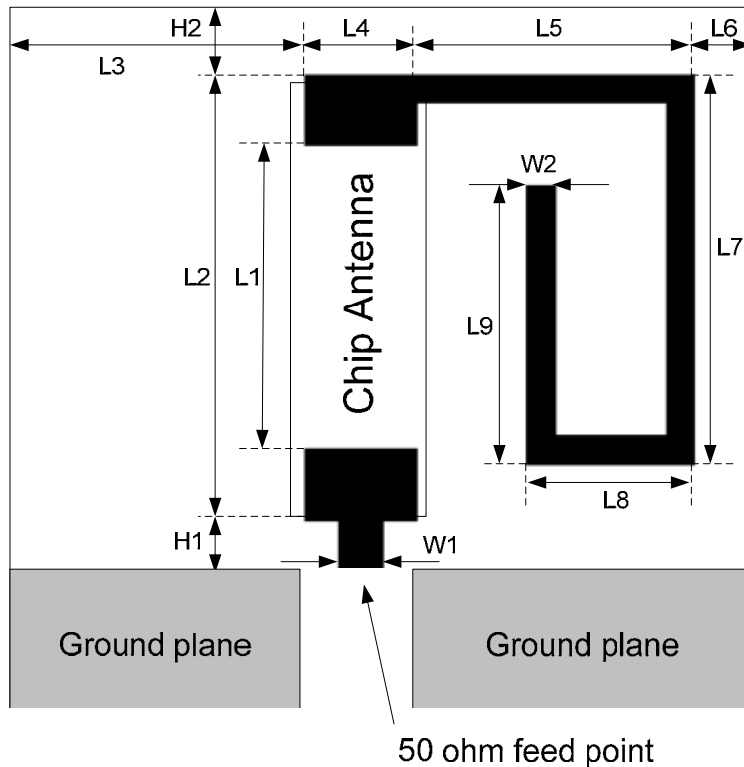

Figure 2. Antenna Dimensions

H1	1.0 mm	L6	2.7 mm
H2	1.3 mm	L7	7.0 mm
L1	5.5 mm	L8	3.0 mm (2.5 mm for 915 MHz)
L2	8.0 mm	L9	5.0 mm (0.0 mm for 915 MHz)
L3	12.8 mm	W1	0.5 mm
L4	2.0 mm	W2	0.8 mm
L5	5.0 mm		

Table 1. Antenna Dimensions

Figure 3 shows how the reflection at the feed point of the antenna is affected by the length of the PCB trace. The blue line shows the measured reflection with the original length. The center frequency can be moved to 915 MHz by adjusting the length of the PCB trace. This is shown by the green line in Figure 3 which is based on a measurement on a board with L9 = 0 mm and L8 = 2.5 mm.

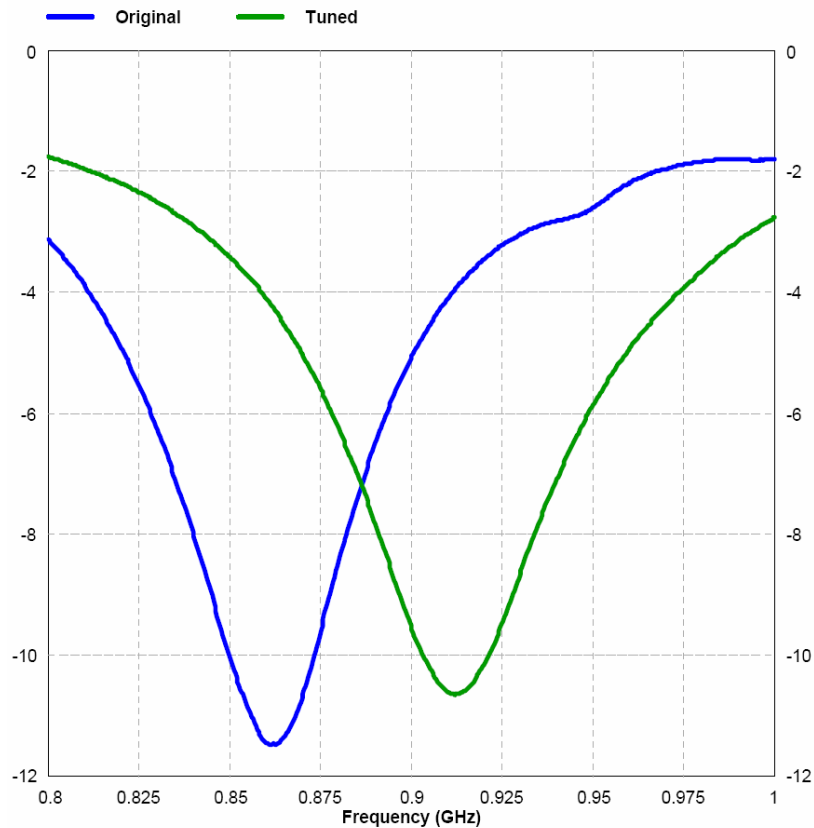

Figure 3. Reflection at the Feed Point of the Antenna

Notice that plastic encapsulation and other objects in the vicinity of the antenna could affect the performance. Thus characterization and tuning should be done with the antenna placed in the environment in which it is going to operate. See Design Note 001 for more information about antenna tuning and reflection measurements [1].

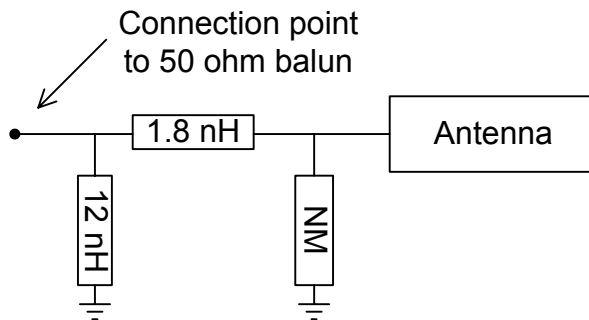

Figure 4. Recommended Matching

Two matching components are being used to obtain a proper impedance match and thus low reflections at the feed point of the antenna. Figure 4 shows the matching network and the recommended values of the two inductors. Inductors from two different vendors have been tested and both gave the same result, see Table 2 for details. Notice that the layout of the CC1111 dongle gives the possibility for another shunt component, marked NM in Figure 4. This can be used if the implementation of the antenna requires additional tuning.

Vendor	Type
Johanson Technology	L-07
Murata	LGQ15H

Table 2. Tested Matching Components

The distance to the board edge, L3 and L6 is not critical. The antenna can be implemented on a PCB with different width than in the reference design, but it is important that no components, ground plane or other metallic objects are implemented close to the antenna. Especially the area under the antenna should not have such objects implemented. Shape and size of the ground plane will affect the radiation pattern. Thus the performance will depend on the layout of the board and what kind of computer the dongle is plugged into.

Since there is no ground plane beneath the antenna, PCB thickness will have little effect on the performance. The results presented in this design note are based on an antenna implemented on a PCB with 1.6 mm thickness.

4 Measurement Results

All results presented in this chapter are based on measurements performed with CC1111 USB Dongle [1]. To reflect the performance during normal operation most of the measurements were done with the dongle placed in a laptop.

4.1 Radiation Pattern

The radiation pattern was measured in three planes, XY, XZ and YZ with the dongle plugged in a laptop. The radiation pattern was also measured in the XY plane without the laptop. This was done to give an indication of the performance for other types of designs using the same antenna. The USB dongle was powered by a battery for this measurement. Table 3 shows the minimum, maximum and average radiation measured when transmitting with 10 dBm output power. Figure 5 shows how to relate all the radiation patterns to the orientation of the antenna. The reference level stated in the bottom right corner of the radiation pattern plots specifies the radiation level at the outer circle. Some of the plots presented in this section do not have proper scaling. Thus the peak gain is higher than the stated reference level on some of the plots.

	With Laptop						Without Laptop	
	XY HP	XY VP	XZ HP	XZ VP	YZ HP	XZ VP	XY HP	XP VP
AVG	+3.5	-0.2	+3.2	-3.7	-0.3	+6.7	-0.5	-16.4
Min	-15.4	-12.3	-16.7	-30.6	-12.6	+2.0	-30.8	-27.2
Max	+9.9	+6.1	+10.7	+5.1	+7.2	+9.0	+6.1	-9.3

Table 3. Radiation Properties. All Numbers in dBm

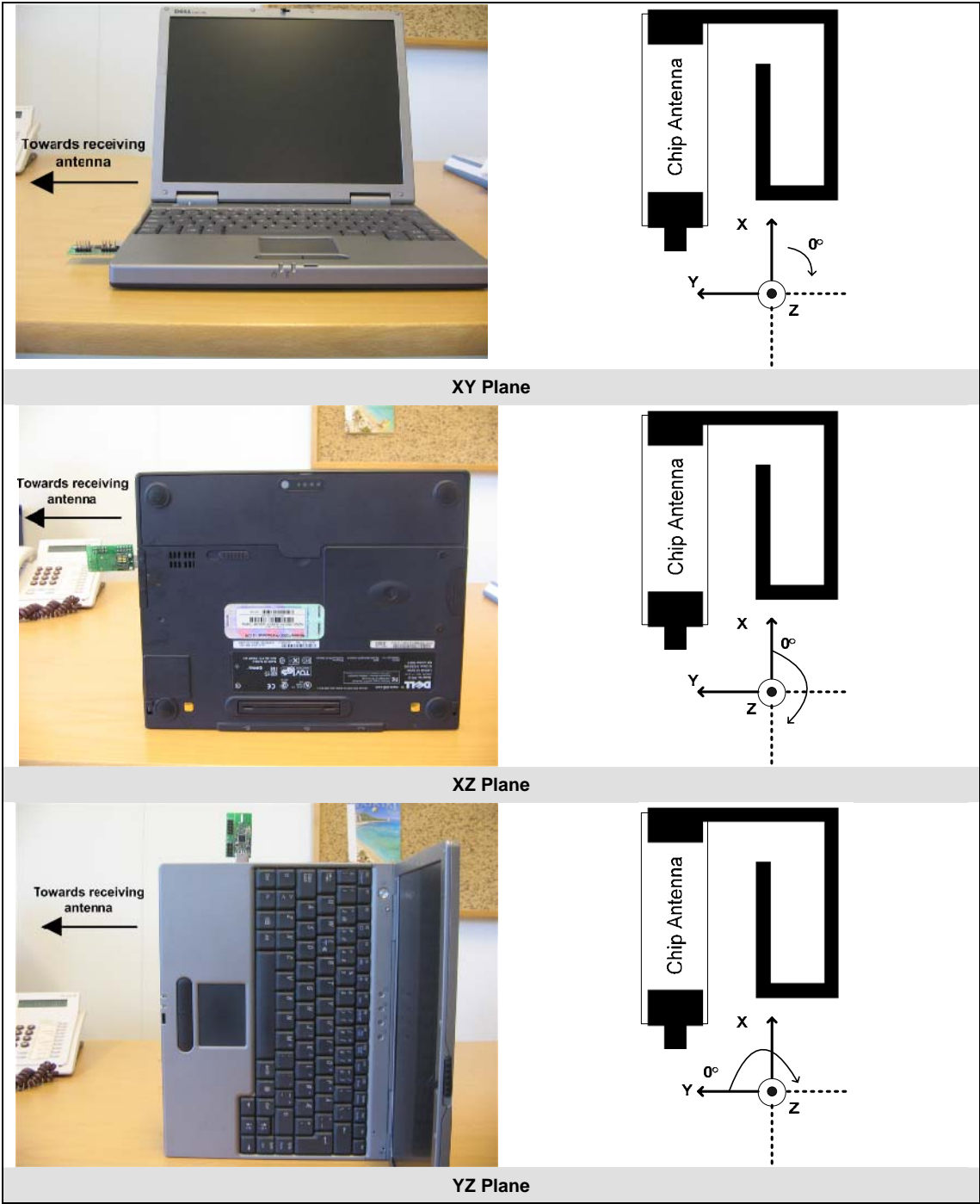
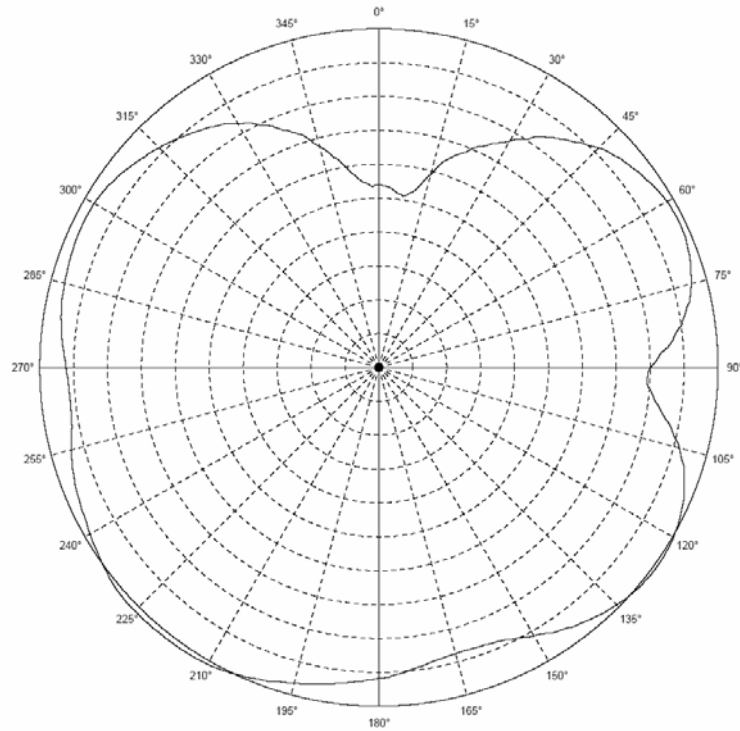

Figure 5. How to Relate the Antenna to the Radiation Patterns



Horizontal Polarization
CC1111 USB dongle XY in laptop

CF 866,000 MHz
5 dB/ div
Ref Lev: 9,0 dBm

Figure 6. XY HP in Laptop

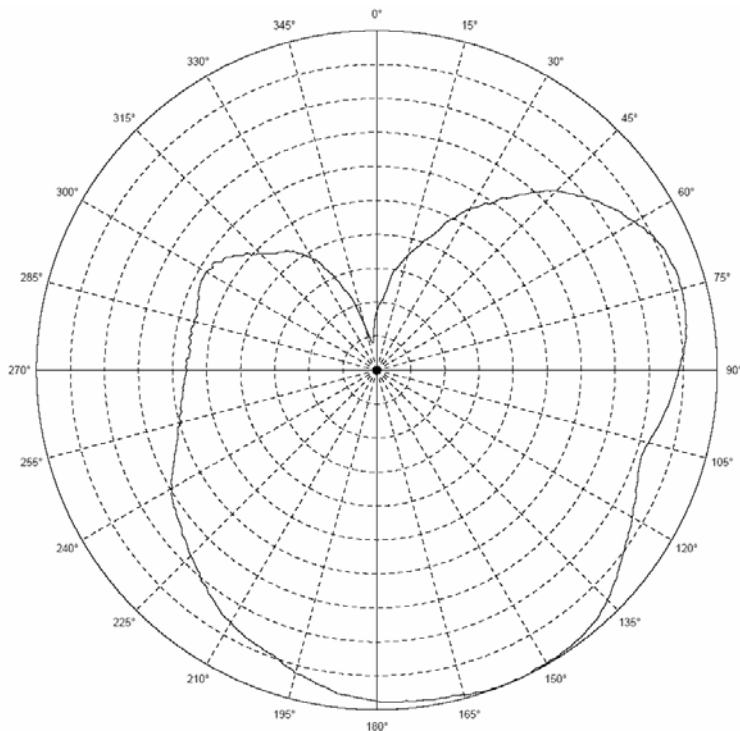

Vertical Polarization
CC1111 USB dongle XY in laptop

CF 866,000 MHz
2 dB/ div
Ref Lev: 6,0 dBm

Figure 7. XY VP in Laptop

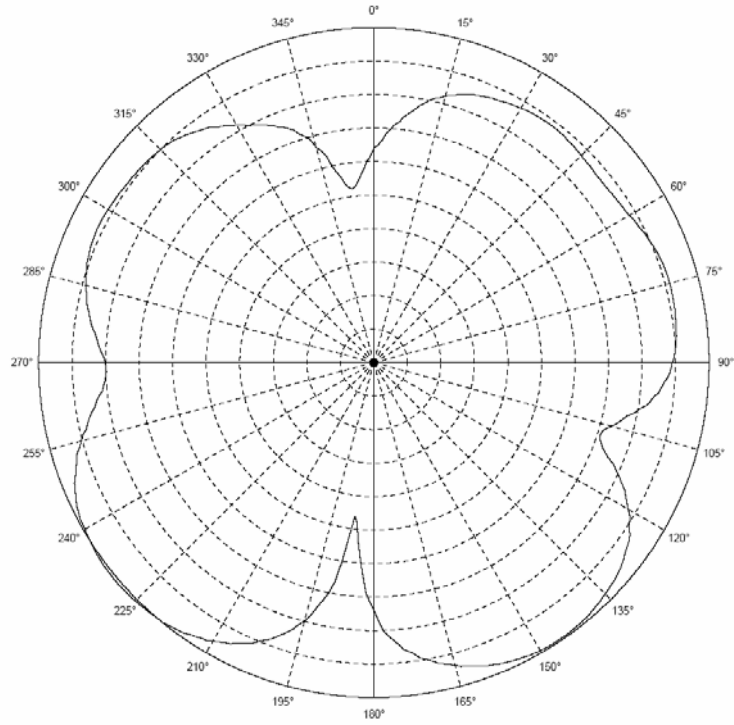

Horizontal Polarization
CC1111 USB Dongle XZ in Laptop

CF 866.500 MHz
5 dB/div
Ref Lev: 10,2 dBm

Figure 8. XZ HP in Laptop

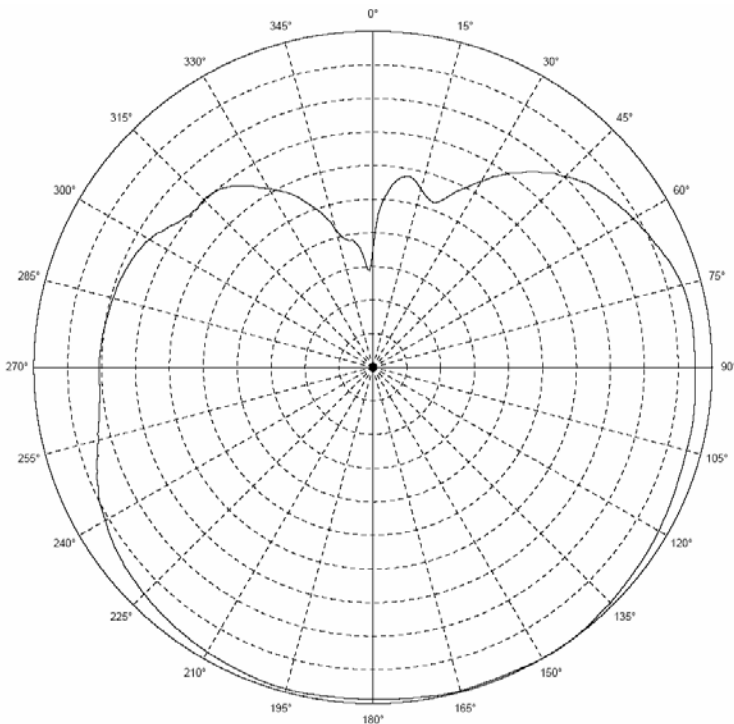

Vertical Polarization
CC1111 USB Dongle XZ in Laptop

CF 866.500 MHz
5 dB/div
Ref Lev: 5,0 dBm

Figure 9. XZ VP in Laptop

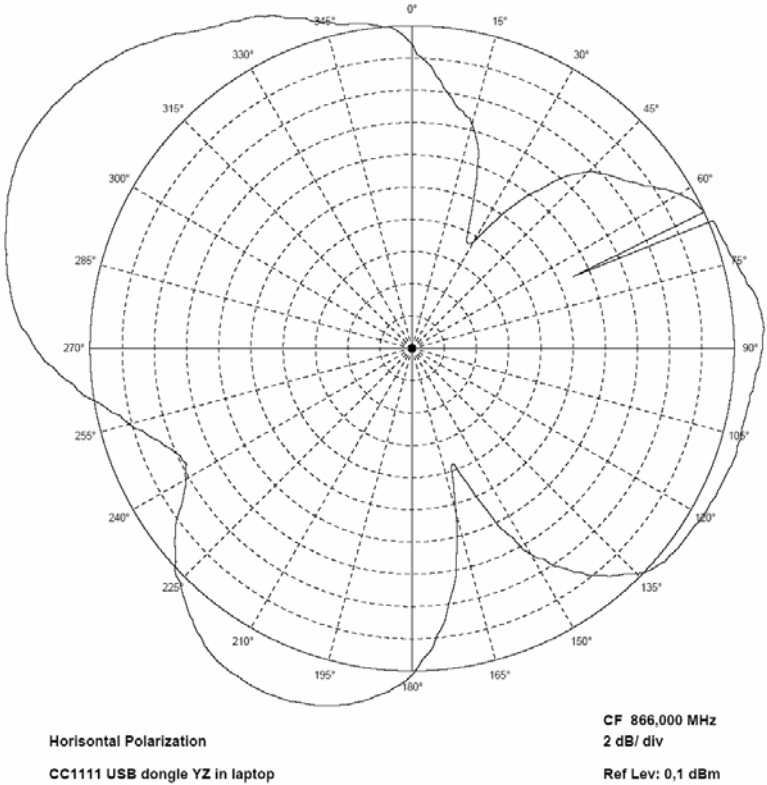

Figure 10. YZ HP in Laptop

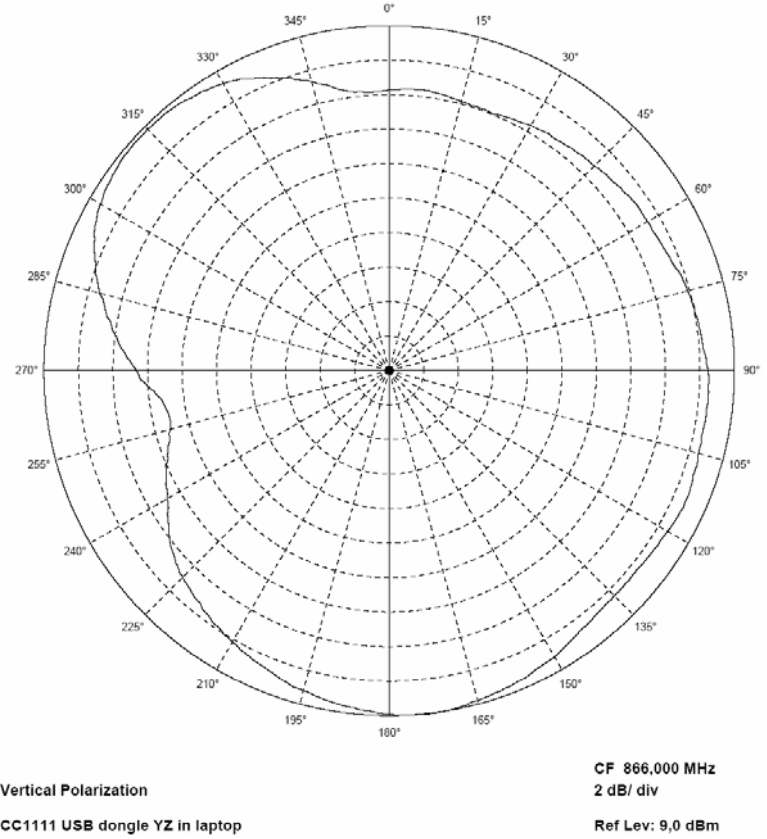
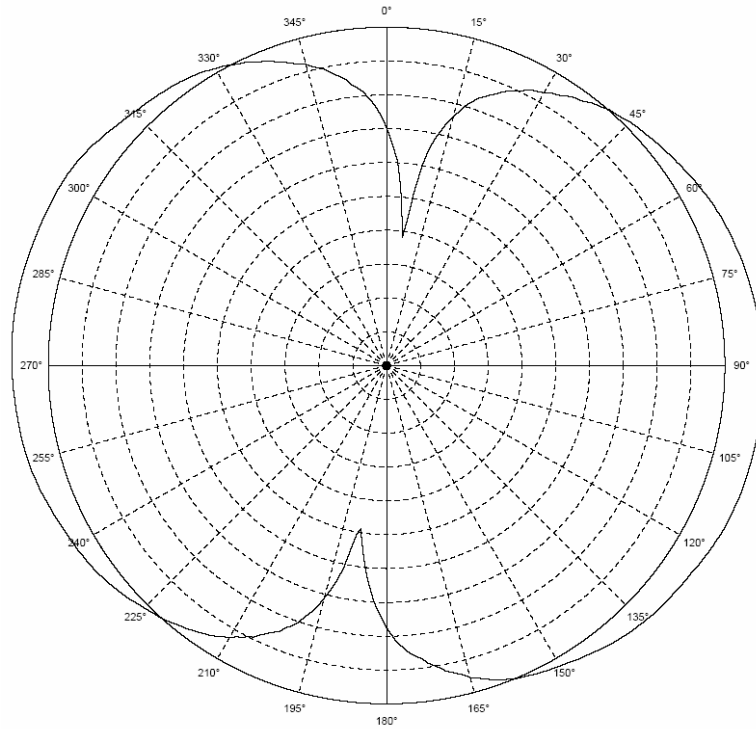

Figure 11. YZ VP in Laptop



Horizontal Polarization
CC1111 USB Dongle XY

CF 866,470 MHz
5 dB/ div
Ref Lev: 0,1 dBm

Figure 12. XY HP. Only CC1111 USB Dongle and Battery

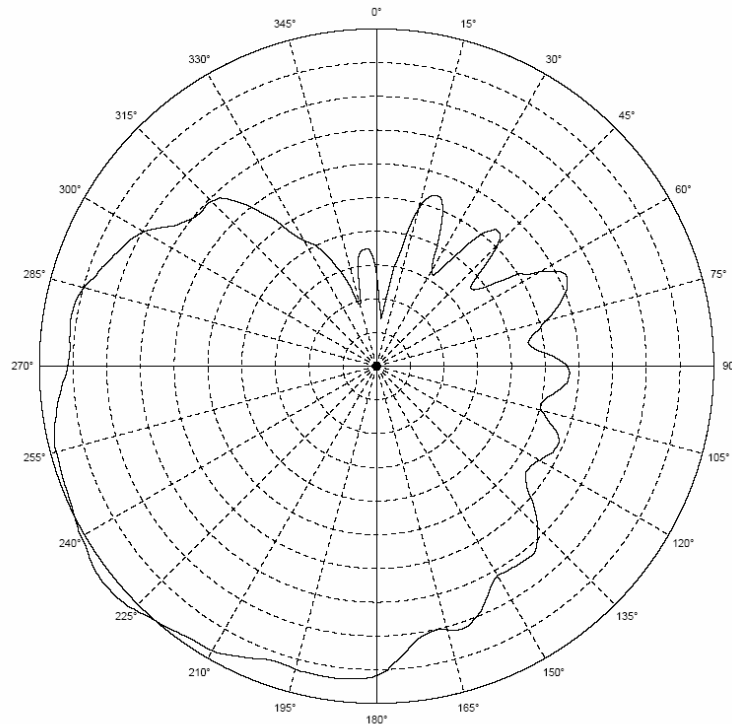

Vertical Polarization
CC1111 USB Dongle XY

CF 866,470 MHz
2 dB/ div
Ref Lev: -10,0 dBm

Figure 13. XY VP. Only CC1111 USB Dongle and Battery

4.2 Bandwidth

A way of measuring the bandwidth after the antenna is implemented on a PCB and connected to a transmitter is to write test software that steps a carrier across the frequency band of interest. By using the “Max hold” function on a spectrum analyzer the variation in output power across the frequency band can easily be measured. Figure 14 shows how the USB dongle output power varies when the PCB is horizontally oriented and pointing away from the receiving antenna. This corresponds to 180° in Figure 6 . Notice that the bandwidth will vary with polarization and orientation of the antenna.

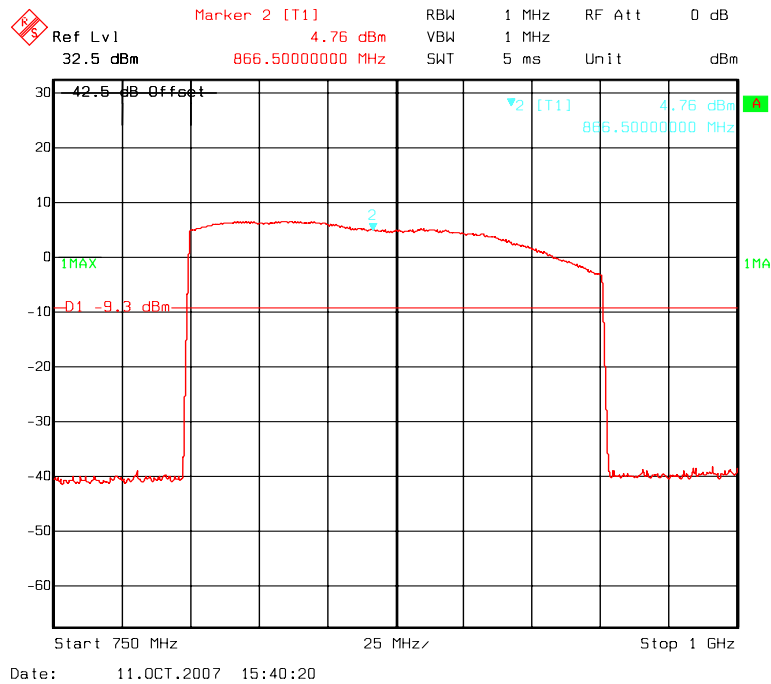

Figure 14. Bandwidth

4.3 Harmonic Emission

Harmonic emission was measured with the CC1111 transmitting at 868 MHz with 10 dBm output power and the USB dongle plugged into the laptop. The measured harmonic emission is shown in Table 4.

Frequency	Emission
2. harm 1732 MHz	-55.5 dBm
3. harm 2599 MHz	-55.6 dBm
4. harm 3465 MHz	-56.9 dBm
5. harm 4332 MHz	-57.6 dBm
6. harm 5198 MHz	-46.2 dBm
7. harm 6065 MHz	-39.0 dBm
8. harm 6931 MHz	-50.2 dBm
9. harm 7798 MHz	-56.9 dBm
10. harm 8664 MHz	-48.9 dBm

Table 4. Harmonic Emission

4.4 TX Spurious Emission 30 - 1 GHz

A sweep from 30 MHz to 1 GHz was done to measure spurious emission. All results in section 4.4 are without correction factor, but shows that no spurs were measured to be above the noise floor. The test was performed with CC1111 transmitting at 868 MHz with 10 dBm output power and the dongle plugged into the laptop.

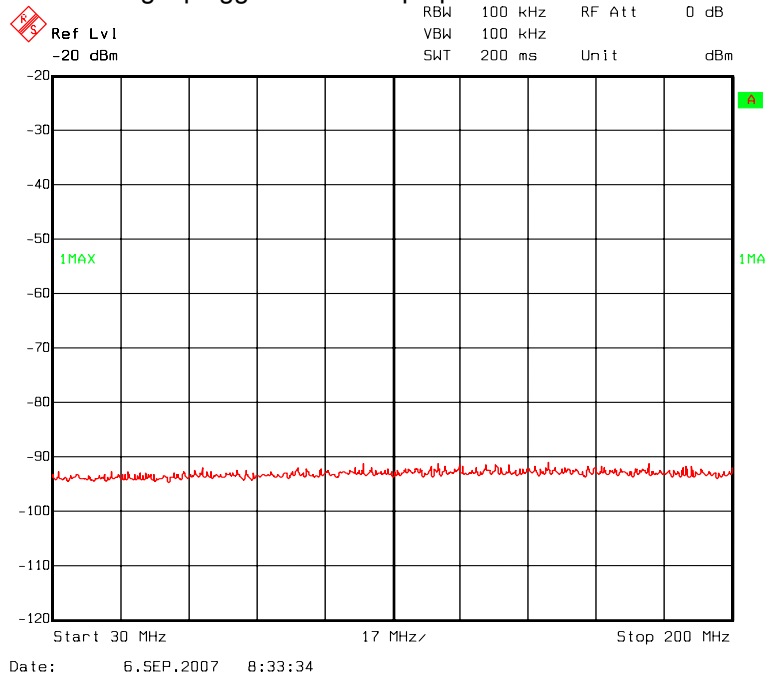

Figure 15. 30 - 200 MHz. Vertical Polarization

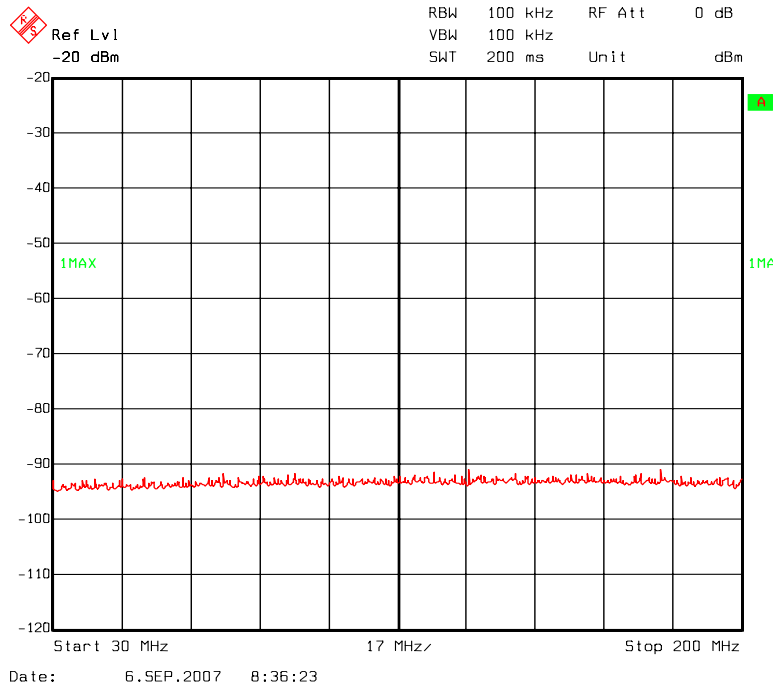

Figure 16. 30 - 200 MHz. Horizontal Polarization

Design Note DN016

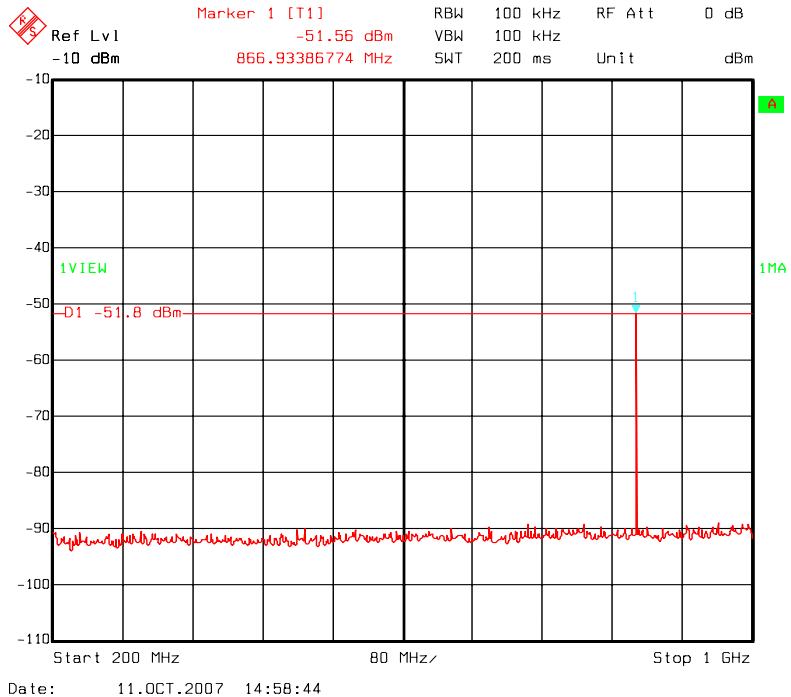

Figure 17. 200 MHz - 1 GHz. Vertical Polarization

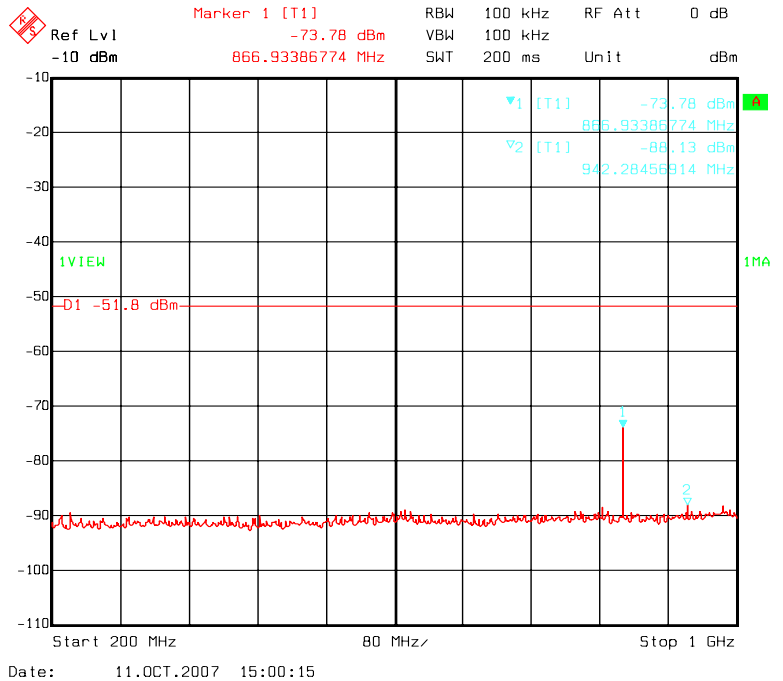

Figure 18. 200 MHz - 1 GHz. Horizontal Polarization

4.5 VCO Leakage

Figure 19 shows the measured CC1111 VCO leakage RX. The measured level is below ETSI limit of -47 dBm. This measurement was done with the USB dongle plugged into the laptop.

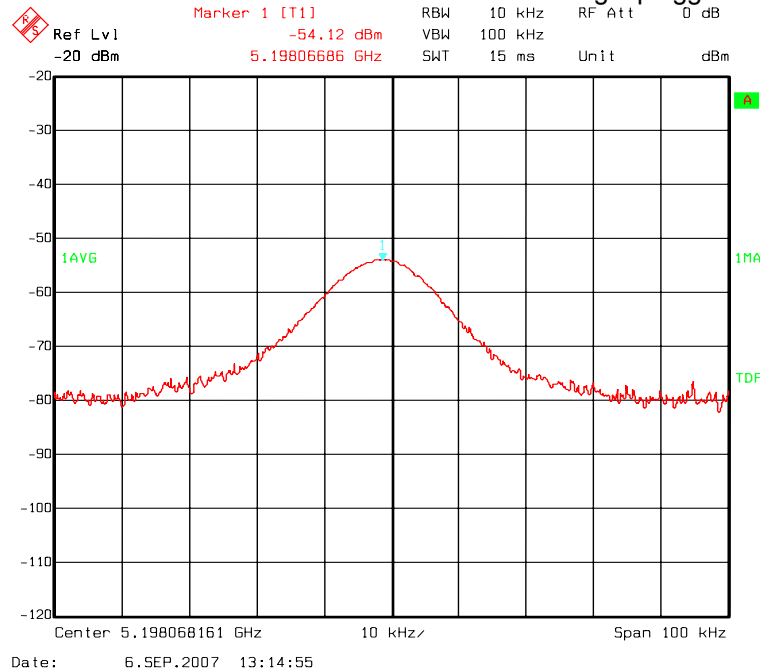

Figure 19. VCO leakage. Horizontal Polarization

5 Compliance with Regulatory Standards

Measurements on the CC1111 USB dongle show that spurious and harmonic emissions are below ETSI and FCC limits. For compliance with ETSI it is not recommended to use CC1111 for operation between 863 and 865.5 MHz, due to a spur close to carrier which will violate the -36 dBm ETSI limit. For more information and recommendations on how to comply with the different ETSI sub bands please see Application Note 050 [4].

6 Conclusion

The antenna solution presented in this document performs well for all frequencies in the 868 MHz and 915 MHz ISM band. Table 5 lists the most important properties for the presented antenna. Note that the gain numbers are related to an isotropic antenna and thus given in dBi.

Peak gain XY Plane with laptop	-0.1 dBi
Peak gain XZ Plane with laptop	+0.7 dBi
Peak gain YZ Plane with laptop	-1.0 dBi
Peak gain XY Plane without laptop	-3.9 dBi
Reflection 863 – 870 MHz	< -10 dB
Reflection 902 – 928 MHz (L9 = 0 mm, L8 = 2.5 mm)	< -9.0 dB
Antenna Size	8.5 mm x 7.8 mm

Table 5. Summary of the Antenna Properties

7 References

- [1] CC1111 Data Sheet ([cc1111f16.pdf](#))
- [2] DN001 Antenna Measurement with Network Analyzer ([swra096.pdf](#))
- [3] CC1111 USB Dongle Reference Design ([swrr049.zip](#))
- [4] AN050 Using the CC1101 in the European 868MHz SRD band ([swra146.pdf](#))
- [5] Full Detail Specification of 0868AT43A0020
<http://www.johansontechnology.com/products/rfc/ant/>
- [6] Contact information: <http://www.johansontechnology.com/sales/>

8 Appendix A

High Frequency Ceramic Solutions

Subset of Detail Specification

868MHz Antenna	P/N 0868AT43A0020
Summary Specification: 06/06/07	

General Specifications

Part Number	0868AT43A0020
Frequency Range	858 - 878 Mhz
Peak Gain	-1.0 dBi typ. (XZ-total)
Average Gain	-4.0 dBi typ. (XZ-total)
Return Loss	9.5 dB min.

Input Power	3W max.
Impedance	50 Ω
Operating Temperature	-40 to +85°C
Reel Quantity	1,000
MSL	2

No.	Function	Terminal Configuration
1	Feeding Point	
2	NC	

Mechanical Dimensions

	In	mm
L	0.276 ± 0.008	7.00 ± 0.20
W	0.079 ± 0.008	2.00 ± 0.20
T	0.031 +.004/-0.008	0.80 +0.1/-0.2
a	0.020 ± 0.012	0.50 ± 0.30

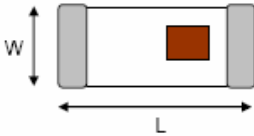
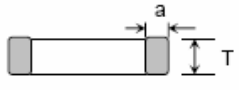
Mounting Considerations

Mount these devices with brown mark facing up. Units: mm
 * Line width should be designed to provide 50 Ω impedance matching characteristics.

With Matching Circuit

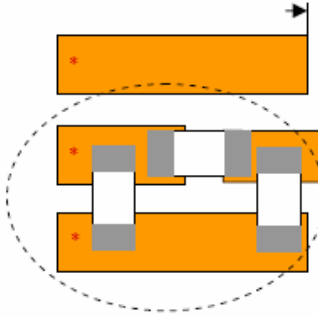

Matching circuits

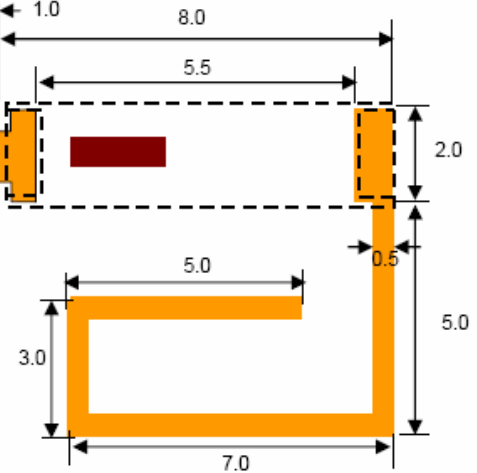

Johanson Technology, Inc. reserves the right to make design changes without notice.
 All sales are subject to Johanson Technology, Inc. terms and conditions.



www.johansontechnology.com
 4001 Calle Tecate • Camarillo, CA 93012 • TEL 805.389.1166 FAX 805.389.1821
 2007 Johanson Technology, Inc. All Rights Reserved

9 General Information

9.1 Document History

Revision	Date	Description/Changes
SWRA160B	2009.08.20	Added CC430 to list of devices
SWRA160A	2008.04.08	Added information about matching components.
SWRA160	2007.10.25	Initial release.

IMPORTANT NOTICE

Texas Instruments Incorporated and its subsidiaries (TI) reserve the right to make corrections, modifications, enhancements, improvements, and other changes to its products and services at any time and to discontinue any product or service without notice. Customers should obtain the latest relevant information before placing orders and should verify that such information is current and complete. All products are sold subject to TI's terms and conditions of sale supplied at the time of order acknowledgment.

TI warrants performance of its hardware products to the specifications applicable at the time of sale in accordance with TI's standard warranty. Testing and other quality control techniques are used to the extent TI deems necessary to support this warranty. Except where mandated by government requirements, testing of all parameters of each product is not necessarily performed.

TI assumes no liability for applications assistance or customer product design. Customers are responsible for their products and applications using TI components. To minimize the risks associated with customer products and applications, customers should provide adequate design and operating safeguards.

TI does not warrant or represent that any license, either express or implied, is granted under any TI patent right, copyright, mask work right, or other TI intellectual property right relating to any combination, machine, or process in which TI products or services are used. Information published by TI regarding third-party products or services does not constitute a license from TI to use such products or services or a warranty or endorsement thereof. Use of such information may require a license from a third party under the patents or other intellectual property of the third party, or a license from TI under the patents or other intellectual property of TI.

Reproduction of TI information in TI data books or data sheets is permissible only if reproduction is without alteration and is accompanied by all associated warranties, conditions, limitations, and notices. Reproduction of this information with alteration is an unfair and deceptive business practice. TI is not responsible or liable for such altered documentation. Information of third parties may be subject to additional restrictions.

Resale of TI products or services with statements different from or beyond the parameters stated by TI for that product or service voids all express and any implied warranties for the associated TI product or service and is an unfair and deceptive business practice. TI is not responsible or liable for any such statements.

TI products are not authorized for use in safety-critical applications (such as life support) where a failure of the TI product would reasonably be expected to cause severe personal injury or death, unless officers of the parties have executed an agreement specifically governing such use. Buyers represent that they have all necessary expertise in the safety and regulatory ramifications of their applications, and acknowledge and agree that they are solely responsible for all legal, regulatory and safety-related requirements concerning their products and any use of TI products in such safety-critical applications, notwithstanding any applications-related information or support that may be provided by TI. Further, Buyers must fully indemnify TI and its representatives against any damages arising out of the use of TI products in such safety-critical applications.

TI products are neither designed nor intended for use in military/aerospace applications or environments unless the TI products are specifically designated by TI as military-grade or "enhanced plastic." Only products designated by TI as military-grade meet military specifications. Buyers acknowledge and agree that any such use of TI products which TI has not designated as military-grade is solely at the Buyer's risk, and that they are solely responsible for compliance with all legal and regulatory requirements in connection with such use.

TI products are neither designed nor intended for use in automotive applications or environments unless the specific TI products are designated by TI as compliant with ISO/TS 16949 requirements. Buyers acknowledge and agree that, if they use any non-designated products in automotive applications, TI will not be responsible for any failure to meet such requirements.

Following are URLs where you can obtain information on other Texas Instruments products and application solutions:

Products

Amplifiers	amplifier.ti.com
Data Converters	dataconverter.ti.com
DLP® Products	www.dlp.com
DSP	dsp.ti.com
Clocks and Timers	www.ti.com/clocks
Interface	interface.ti.com
Logic	logic.ti.com
Power Mgmt	power.ti.com
Microcontrollers	microcontroller.ti.com
RFID	www.ti-rfid.com
RF/IF and ZigBee® Solutions	www.ti.com/lprf

Applications

Audio	www.ti.com/audio
Automotive	www.ti.com/automotive
Broadband	www.ti.com/broadband
Digital Control	www.ti.com/digitalcontrol
Medical	www.ti.com/medical
Military	www.ti.com/military
Optical Networking	www.ti.com/opticalnetwork
Security	www.ti.com/security
Telephony	www.ti.com/telephony
Video & Imaging	www.ti.com/video
Wireless	www.ti.com/wireless

Mailing Address: Texas Instruments, Post Office Box 655303, Dallas, Texas 75265
Copyright © 2009, Texas Instruments Incorporated